

**COSEL**|科索 DBS700B28 **PDF**

**COSEL**

**深圳创唯电子有限公司**

*<http://www.cosef.net>*



# DBS-series



## Feature

- Ideal for distributed power systems
- Thin and small size
- Built-in overcurrent, overvoltage and thermal protection circuits
- Built-in remote ON/OFF (on both side of input and output)
- Inverter operating monitoring (IOG)
- Mounting hole (M3 tapped)
- The beat noise is decreased by installing of the crystal oscillator (DBS700)

## CE marking

- Low Voltage Directive
- RoHS Directive

## Safety agency approvals

- UL, C-UL recognized, TÜV approved

## 5-year warranty

# DBS100A/DBS150A

DB S 150 A 15

① ② ③ ④ ⑤

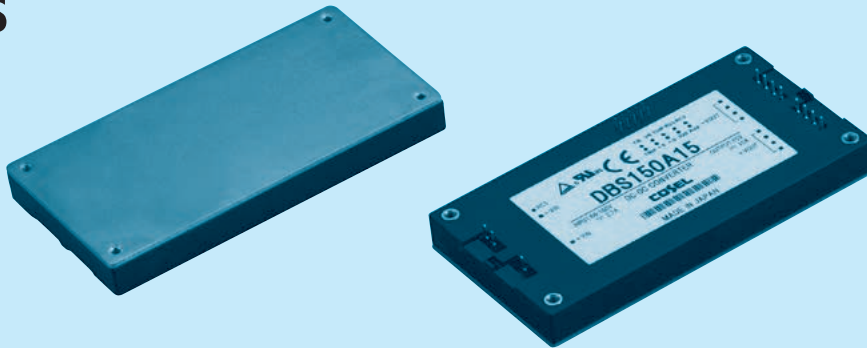

- ① Series name
- ② Single output
- ③ Output wattage
- ④ Input voltage  
A :DC110V input
- ⑤ Output voltage

| MODEL                 | DBS100A05 | DBS100A13R8 | DBS150A12 | DBS150A15 | DBS150A24 |
|-----------------------|-----------|-------------|-----------|-----------|-----------|
| MAX OUTPUT WATTAGE[W] | 100       | 100.7       | 150       | 150       | 151       |
| DC OUTPUT             | 5V 20A    | 13.8V 7.3A  | 12V 12.5A | 15V 10A   | 24V 6.3A  |

## SPECIFICATIONS

|                                 | MODEL   | DBS100A05   | DBS100A13R8    | DBS150A12      | DBS150A15      | DBS150A24      |        |
|---------------------------------|---|---|----------------|----------------|----------------|----------------|--------|
| INPUT                           | VOLTAGE[V]  | DC45 - 160  |                | DC66 - 160     |                |                |        |
|                                 | CURRENT[A]  | *1 1.11typ  | 1.10typ        | 1.57typ        | 1.59typ        | 1.58typ        |        |
|                                 | EFFICIENCY[%]   | *1 82typ  | 83typ          | 87typ          | 86typ          | 87typ          |        |
| OUTPUT                          | VOLTAGE[V]  | 5   | 13.8           | 12             | 15             | 24             |        |
|                                 | CURRENT[A]  | 20  | 7.3            | 12.5           | 10             | 6.3            |        |
|                                 | LINE REGULATION[mV]   | 20max   | 60max          | 40max          | 60max          | 95max          |        |
|                                 | LOAD REGULATION[mV]   | 40max   | 150max         | 100max         | 150max         | 190max         |        |
|                                 | RIPPLE[mVp-p]   | 0 to +85°C *2   | 80max          | 120max         | 120max         | 120max         | 120max |
|                                 |   | -20 - 0°C *2  | 140max         | 160max         | 160max         | 160max         | 160max |
|                                 | RIPPLE NOISE[mVp-p]   | 0 to +85°C *2   | 100max         | 150max         | 150max         | 150max         | 150max |
|                                 |   | -20 - 0°C *2  | 150max         | 180max         | 180max         | 180max         | 180max |
|                                 | TEMPERATURE REGULATION[mV]  | 0 to +65°C  | 50max          | 180max         | 120max         | 180max         | 280max |
|                                 |   | -20 to +85°C  | 85max          | 310max         | 200max         | 310max         | 480max |
| DRIFT[mV]                       | *3 20max  | 60max   | 40max          | 60max          | 90max          |                |        |
| START-UP TIME[ms]               | 200max (DCIN 110V, Io=100%)   |   |                |                |                |                |        |
| OUTPUT VOLTAGE ADJUSTMENT RANGE | Fixed (TRM pin open), 60 - 110% adjustable by external VR or external voltage |   |                |                |                |                |        |
| OUTPUT VOLTAGE SETTING[V]       | 4.90 - 5.20   | 13.25 - 14.35   | 11.60 - 12.60  | 14.40 - 15.60  | 23.04 - 24.96  |                |        |
| PROTECTION CIRCUIT AND OTHERS   | OVERCURRENT PROTECTION  | Works over 105% of rating and recovers automatically  |                |                |                |                |        |
|                                 | OVERVOLTAGE PROTECTION  | 5.75 - 7.00V  | 15.87 - 19.32V | 13.80 - 16.80V | 17.25 - 21.00V | 27.60 - 33.60V |        |
|                                 | REMOTE SENSING  | Provided  |                |                |                |                |        |
|                                 | REMOTE ON/OFF   | Provided (On both side of input and output)   |                |                |                |                |        |
| ISOLATION                       | INPUT-OUTPUT  | AC3,000V 1minute, Cutoff current = 10mA, DC500V 50MΩ min (20±15°C)  |                |                |                |                |        |
|                                 | INPUT-FG  | AC2,000V 1minute, Cutoff current = 10mA, DC500V 50MΩ min (20±15°C)  |                |                |                |                |        |
|                                 | OUTPUT-FG   | AC500V 1minute, Cutoff current = 100mA, DC500V 50MΩ min (20±15°C)   |                |                |                |                |        |
|                                 | OUTPUT-RC2.RC3  | AC100V 1minute, Cutoff current = 100mA, DC100V 10MΩ min (20±15°C)   |                |                |                |                |        |
| ENVIRONMENT                     | OPERATING TEMP.HUMID.AND ALTITUDE *4  | -20 to +85°C (On aluminum base plate), 20 - 95%RH (Non condensing) (Refer to "Derating"), 3,000m (10,000feet) max |                |                |                |                |        |
|                                 | STORAGE TEMP.HUMID.AND ALTITUDE   | -40 to +85°C, 20 - 95%RH (Non condensing), 9,000m (30,000feet) max  |                |                |                |                |        |
|                                 | VIBRATION   | 10 - 55Hz, 49.0m/s <sup>2</sup> (5G), 3minutes period, 60minutes each along X, Y and Z axis                       |                |                |                |                |        |
|                                 | IMPACT  | 196.1m/s <sup>2</sup> (20G), 11ms once each along X, Y and Z axis   |                |                |                |                |        |
| SAFETY                          | AGENCY APPROVALS  | UL60950-1, C-UL, EN60950-1  |                |                |                |                |        |
| OTHERS                          | CASE SIZE/WEIGHT  | 61 × 12.7 × 116.8mm [2.4 × 0.5 × 4.6 inches] (W×H×D) / 150g max   |                |                |                |                |        |
|                                 | COOLING METHOD  | Conduction cooling (e.g. heat radiation from the aluminum base plate to the attached heat sink)                   |                |                |                |                |        |

\*1 At rated input(DC110V) and rated load.

\*2 Ripple and ripple noise is measured by using measuring board with the recommended capacitor Co & the film capacitor 0.1 μF. Measured by 20MHz oscilloscope or Ripple-Noise meter (Equivalent to KEISOKU-GIKEN:RM101). Refer to the manual.

\*3 Drift is the change in DC output for an eight hour period after a half-hour warm-up at 25°C, with the input voltage held constant at the rated input/output.

\*4 Please consult us in regard to use from -40°C.

## External view

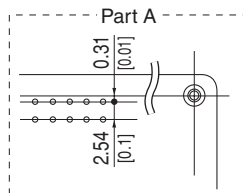
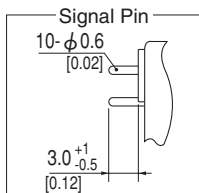
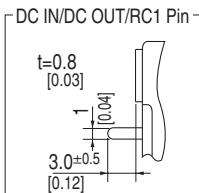
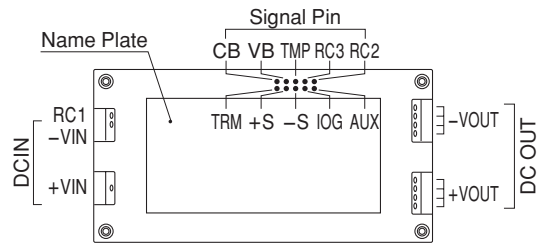
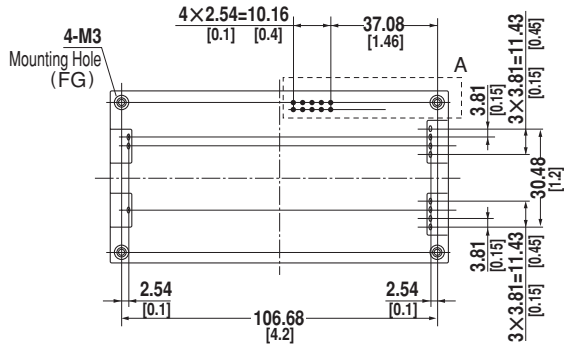
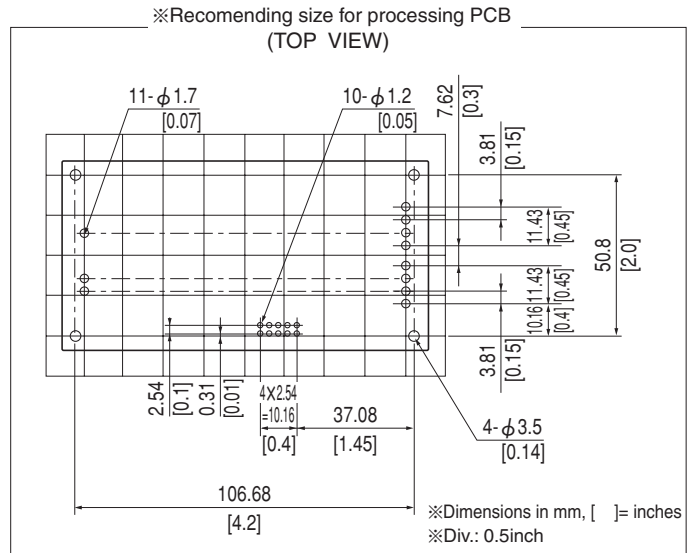
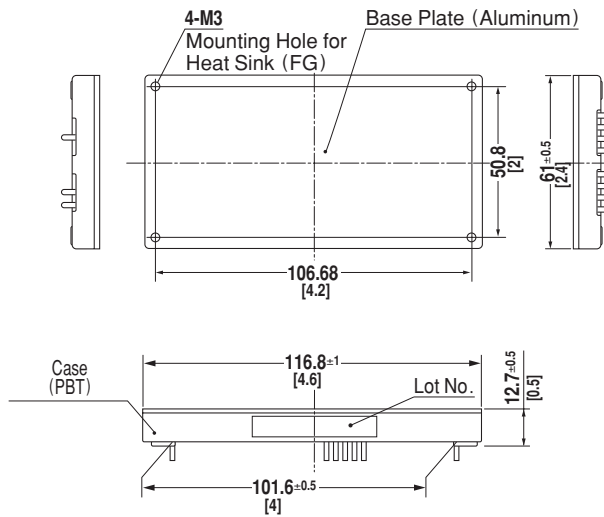

- ※Weight: 150g max
- ※Tolerance: ±0.3 [±0.012]
- ※Base Plate: Aluminum
- ※Dimensions in mm, [ ] = inches
- ※Mounting hole screwing torque: 0.49N·m(5.0kgf·cm)

# DBS200B

DB S 200 B 03

① ② ③ ④ ⑤



RoHS

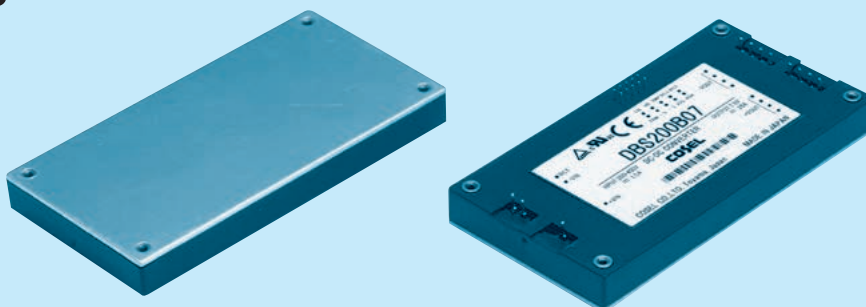

- ① Series name
- ② Single output
- ③ Output wattage
- ④ Input voltage  
B : DC200 - 400V
- ⑤ Output voltage

| MODEL                 | DBS200B03 | DBS200B05 | DBS200B07 | DBS200B12 |
|-----------------------|-----------|-----------|-----------|-----------|
| MAX OUTPUT WATTAGE[W] | 165       | 200       | 210       | 240       |
| DC OUTPUT             | 3.3V 50A  | 5V 40A    | 7.5V 28A  | 12V 20A   |

## SPECIFICATIONS

|                                 | MODEL   | DBS200B03   | DBS200B05    | DBS200B07     | DBS200B12      |        |
|---------------------------------|---|---|--------------|---------------|----------------|--------|
| INPUT                           | VOLTAGE[V]  | DC200 - 400   |              |               |                |        |
|                                 | CURRENT[A]  | *1 0.75typ  | 0.86typ      | 0.87typ       | 0.99typ        |        |
|                                 | EFFICIENCY[%]   | *1 79typ  | 83typ        | 86typ         | 87typ          |        |
| OUTPUT                          | VOLTAGE[V]  | 3.3   | 5            | 7.5           | 12             |        |
|                                 | CURRENT[A]  | 50  | 40           | 28            | 20             |        |
|                                 | LINE REGULATION[mV]   | 16max   | 20max        | 30max         | 40max          |        |
|                                 | LOAD REGULATION[mV]   | 30max   | 40max        | 60max         | 100max         |        |
|                                 | RIPPLE[mVp-p]   | 0 to +85°C *2   | 80max        | 80max         | 100max         | 120max |
|                                 |   | -20 - 0°C *2  | 140max       | 140max        | 150max         | 160max |
|                                 | RIPPLE NOISE[mVp-p]   | 0 to +85°C *2   | 100max       | 100max        | 140max         | 150max |
|                                 |   | -20 - 0°C *2  | 150max       | 150max        | 160max         | 180max |
|                                 | TEMPERATURE REGULATION[mV]  | 0 to +65°C  | 35max        | 50max         | 75max          | 120max |
|                                 |   | -20 to +85°C  | 60max        | 85max         | 130max         | 200max |
| DRIFT[mV]                       | *3  | 16max   | 20max        | 30max         | 40max          |        |
| START-UP TIME[ms]               | 200max (DCIN 280V, Io=100%)   |   |              |               |                |        |
| OUTPUT VOLTAGE ADJUSTMENT RANGE | Fixed (TRM pin open), 60 - 110% adjustable by external VR or external voltage |   |              |               |                |        |
| OUTPUT VOLTAGE SETTING[V]       | 3.25 - 3.45   | 4.90 - 5.20   | 7.25 - 7.85  | 11.60 - 12.60 |                |        |
| PROTECTION CIRCUIT AND OTHERS   | OVERCURRENT PROTECTION  | Works over 105% of rating and recovers automatically  |              |               |                |        |
|                                 | OVERVOLTAGE PROTECTION  | 4.00 - 5.50V  | 5.75 - 7.00V | 8.60 - 10.50V | 13.80 - 16.80V |        |
|                                 | REMOTE SENSING  | Provided  |              |               |                |        |
|                                 | REMOTE ON/OFF   | Provided (On both side of input and output)   |              |               |                |        |
| ISOLATION                       | INPUT-OUTPUT  | AC3,000V 1minute, Cutoff current = 10mA, DC500V 50MΩ min (20±15°C)  |              |               |                |        |
|                                 | INPUT-FG  | AC2,000V 1minute, Cutoff current = 10mA, DC500V 50MΩ min (20±15°C)  |              |               |                |        |
|                                 | OUTPUT-FG   | AC500V 1minute, Cutoff current = 100mA, DC500V 50MΩ min (20±15°C)   |              |               |                |        |
|                                 | OUTPUT-RC2.RC3  | AC100V 1minute, Cutoff current = 100mA, DC100V 10MΩ min (20±15°C)   |              |               |                |        |
| ENVIRONMENT                     | OPERATING TEMP.HUMID.AND ALTITUDE *4  | -20 to +85°C (On aluminum base plate), 20 - 95%RH (Non condensing) (Refer to "Derating"), 3,000m (10,000feet) max |              |               |                |        |
|                                 | STORAGE TEMP.HUMID.AND ALTITUDE   | -40 to +85°C, 20 - 95%RH (Non condensing), 9,000m (30,000feet) max  |              |               |                |        |
|                                 | VIBRATION   | 10 - 55Hz, 49.0m/s <sup>2</sup> (5G), 3minutes period, 60minutes each along X, Y and Z axis                       |              |               |                |        |
|                                 | IMPACT  | 196.1m/s <sup>2</sup> (20G), 11ms once each along X, Y and Z axis   |              |               |                |        |
| SAFETY                          | AGENCY APPROVALS  | UL60950-1, C-UL, EN60950-1, EN50178 Complies with DEN-AN and IEC60950-1   |              |               |                |        |
| OTHERS                          | CASE SIZE/WEIGHT  | 61 × 12.7 × 116.8mm [2.4 × 0.5 × 4.6 inches] (W×H×D) / 150g max   |              |               |                |        |
|                                 | COOLING METHOD  | Conduction cooling (e.g. heat radiation from the aluminum base plate to the attached heat sink)                   |              |               |                |        |

\*1 At rated input(DC280V) and rated load.

\*2 Ripple and ripple noise is measured by using measuring board with the recommended capacitor Co & the film capacitor 0.1 μF. Measured by 20MHz oscilloscope or Ripple-Noise meter (Equivalent to KEISOKU-GIKEN:RM101). Refer to the manual.

\*3 Drift is the change in DC output for an eight hour period after a half-hour warm-up at 25°C, with the input voltage held constant at the rated input/output.

\*4 Please consult us in regard to use from -40°C.

## External view

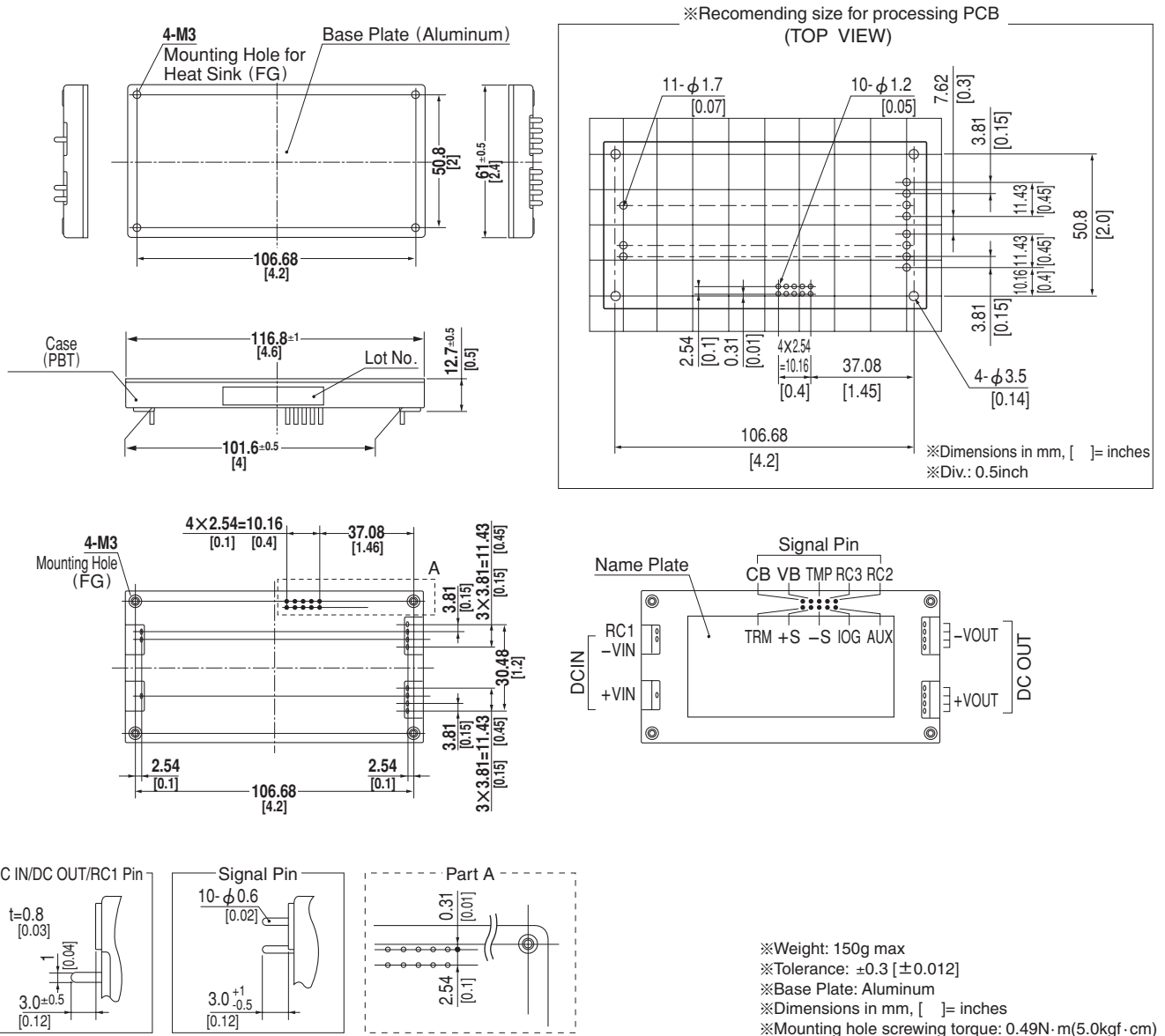

## Performance data

### INPUT CURRENT CHARACTERISTICS (DBS200B12)

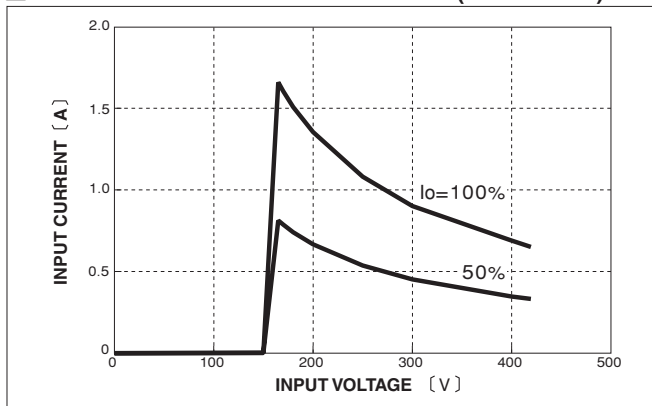

### EFFICIENCY CHARACTERISTICS

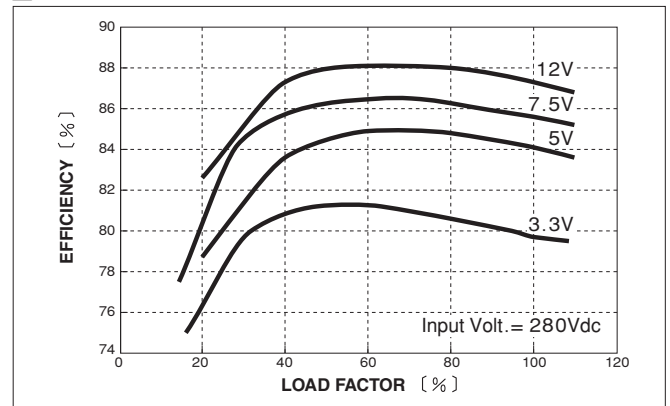

# DBS400B

DB S 400 B 03

① ② ③ ④ ⑤



RoHS

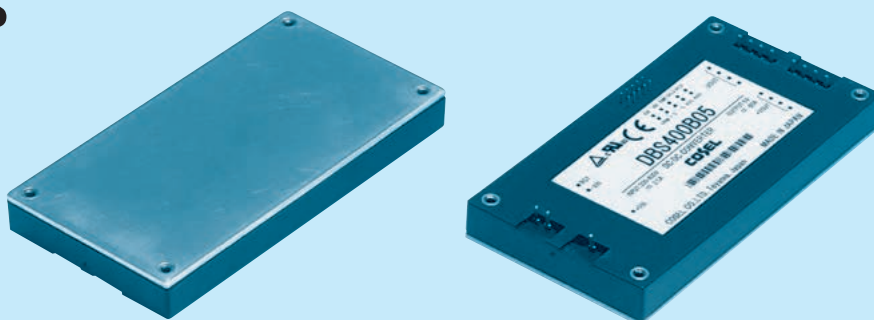

- ① Series name
- ② Single output
- ③ Output wattage
- ④ Input voltage  
B : DC200 - 400V
- ⑤ Output voltage

| MODEL                 | DBS400B03 | DBS400B05 | DBS400B07 | DBS400B12 | DBS400B15 | DBS400B18 | DBS400B24 | DBS400B28 |
|-----------------------|-----------|-----------|-----------|-----------|-----------|-----------|-----------|-----------|
| MAX OUTPUT WATTAGE[W] | 264       | 400       | 405       | 408       | 405       | 396       | 408       | 406       |
| DC OUTPUT             | 3.3V 80A  | 5V 80A    | 7.5V 54A  | 12V 34A   | 15V 27A   | 18V 22A   | 24V 17A   | 28V 14.5A |

## SPECIFICATIONS

|                                 | MODEL   | DBS400B03   | DBS400B05    | DBS400B07     | DBS400B12      | DBS400B15      | DBS400B18      | DBS400B24      | DBS400B28      |        |
|---------------------------------|---|---|--------------|---------------|----------------|----------------|----------------|----------------|----------------|--------|
| INPUT                           | VOLTAGE[V]  | DC200 - 400   |              |               |                |                |                |                |                |        |
|                                 | CURRENT[A]  | *1 1.19typ  | 1.72typ      | 1.68typ       | 1.67typ        | 1.66typ        | 1.61typ        | 1.67typ        | 1.63typ        |        |
|                                 | EFFICIENCY[%]   | *1 79typ  | 83typ        | 86typ         | 87typ          | 87typ          | 89typ          | 87typ          | 88typ          |        |
| OUTPUT                          | VOLTAGE[V]  | 3.3   | 5            | 7.5           | 12             | 15             | 18             | 24             | 28             |        |
|                                 | CURRENT[A]  | 80  | 80           | 54            | 34             | 27             | 22             | 17             | 14.5           |        |
|                                 | LINE REGULATION[mV]   | 16max   | 20max        | 30max         | 40max          | 60max          | 60max          | 95max          | 95max          |        |
|                                 | LOAD REGULATION[mV]   | 30max   | 40max        | 60max         | 100max         | 150max         | 150max         | 190max         | 190max         |        |
|                                 | RIPPLE[mVp-p]   | 0 to +85°C *2   | 80max        | 80max         | 100max         | 120max         | 120max         | 120max         | 120max         | 120max |
|                                 |   | -20 - 0°C *2  | 140max       | 140max        | 150max         | 160max         | 160max         | 160max         | 160max         | 160max |
|                                 | RIPPLE NOISE[mVp-p]   | 0 to +85°C *2   | 100max       | 100max        | 140max         | 150max         | 150max         | 150max         | 150max         | 150max |
|                                 |   | -20 - 0°C *2  | 150max       | 150max        | 160max         | 180max         | 180max         | 180max         | 180max         | 180max |
|                                 | TEMPERATURE REGULATION[mV]  | 0 to +65°C  | 35max        | 50max         | 75max          | 120max         | 180max         | 180max         | 280max         | 280max |
|                                 |   | -20 to +85°C  | 60max        | 85max         | 130max         | 200max         | 310max         | 310max         | 480max         | 480max |
| DRIFT[mV]                       | *3  | 16max   | 20max        | 30max         | 40max          | 60max          | 60max          | 90max          | 90max          |        |
| START-UP TIME[ms]               | 200max (DCIN 280V, Io=100%)   |   |              |               |                |                |                |                |                |        |
| OUTPUT VOLTAGE ADJUSTMENT RANGE | Fixed (TRM pin open), 60 - 110% adjustable by external VR or external voltage |   |              |               |                |                |                |                |                |        |
| OUTPUT VOLTAGE SETTING[V]       | 3.25 - 3.45   | 4.90 - 5.20   | 7.25 - 7.85  | 11.60 - 12.60 | 14.40 - 15.60  | 17.28 - 18.72  | 23.04 - 24.96  | 26.88 - 29.12  |                |        |
| PROTECTION CIRCUIT AND OTHERS   | OVERCURRENT PROTECTION  | Works over 105% of rating and recovers automatically  |              |               |                |                |                |                |                |        |
|                                 | OVERVOLTAGE PROTECTION  | 4.00 - 5.50V  | 5.75 - 7.00V | 8.60 - 10.50V | 13.80 - 16.80V | 17.25 - 21.00V | 20.70 - 25.20V | 27.60 - 33.60V | 32.20 - 39.20V |        |
|                                 | REMOTE SENSING  | Provided  |              |               |                |                |                |                |                |        |
|                                 | REMOTE ON/OFF   | Provided (On both side of input and output)   |              |               |                |                |                |                |                |        |
| ISOLATION                       | INPUT-OUTPUT  | AC3,000V 1minute, Cutoff current = 10mA, DC500V 50MΩ min (20±15°C)  |              |               |                |                |                |                |                |        |
|                                 | INPUT-FG  | AC2,000V 1minute, Cutoff current = 10mA, DC500V 50MΩ min (20±15°C)  |              |               |                |                |                |                |                |        |
|                                 | OUTPUT-FG   | AC500V 1minute, Cutoff current = 100mA, DC500V 50MΩ min (20±15°C)   |              |               |                |                |                |                |                |        |
|                                 | OUTPUT-RC2.RC3  | AC100V 1minute, Cutoff current = 100mA, DC100V 10MΩ min (20±15°C)   |              |               |                |                |                |                |                |        |
| ENVIRONMENT                     | OPERATING TEMP.HUMID.AND ALTITUDE *4  | -20 to +85°C (On aluminum base plate), 20 - 95%RH (Non condensing) (Refer to "Derating"), 3,000m (10,000feet) max |              |               |                |                |                |                |                |        |
|                                 | STORAGE TEMP.HUMID.AND ALTITUDE   | -40 to +85°C, 20 - 95%RH (Non condensing), 9,000m (30,000feet) max  |              |               |                |                |                |                |                |        |
|                                 | VIBRATION   | 10 - 55Hz, 49.0m/s <sup>2</sup> (5G), 3minutes period, 60minutes each along X, Y and Z axis                       |              |               |                |                |                |                |                |        |
|                                 | IMPACT  | 196.1m/s <sup>2</sup> (20G), 11ms once each along X, Y and Z axis   |              |               |                |                |                |                |                |        |
| SAFETY                          | AGENCY APPROVALS  | UL60950-1, C-UL, EN60950-1, EN50178 Complies with DEN-AN and IEC60950-1   |              |               |                |                |                |                |                |        |
| OTHERS                          | CASE SIZE/WEIGHT  | 61 × 12.7 × 116.8mm [2.4 × 0.5 × 4.6 inches] (W×H×D) / 180g max   |              |               |                |                |                |                |                |        |
|                                 | COOLING METHOD  | Conduction cooling (e.g. heat radiation from the aluminum base plate to the attached heat sink)                   |              |               |                |                |                |                |                |        |

\*1 At rated input(DC280V) and rated load.

\*2 Ripple and ripple noise is measured by using measuring board with the recommended capacitor Co & the film capacitor 0.1 μF. Measured by 20MHz oscilloscope or Ripple-Noise meter (Equivalent to KEISOKU-GIKEN:RM101). Refer to the manual.

\*3 Drift is the change in DC output for an eight hour period after a half-hour warm-up at 25°C, with the input voltage held constant at the rated input/output.

\*4 Please consult us in regard to use from -40°C.

## External view

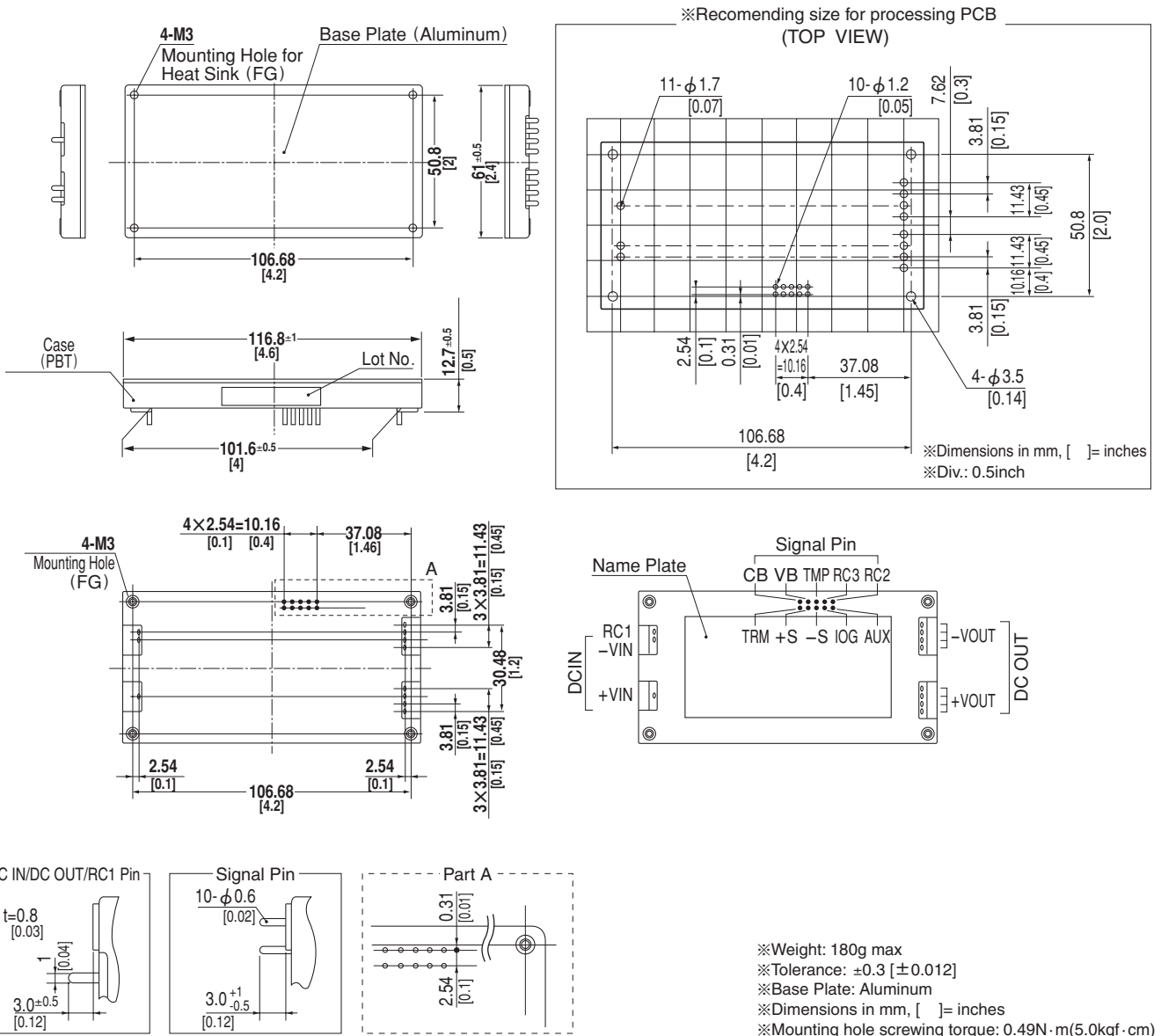

## Performance data

### INPUT CURRENT CHARACTERISTICS (DBS400B12)

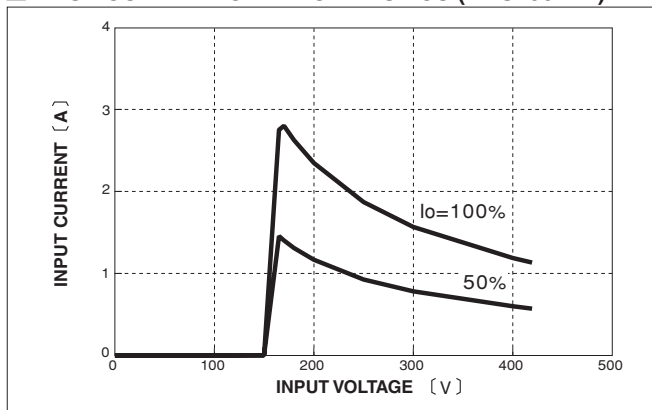

### EFFICIENCY CHARACTERISTICS

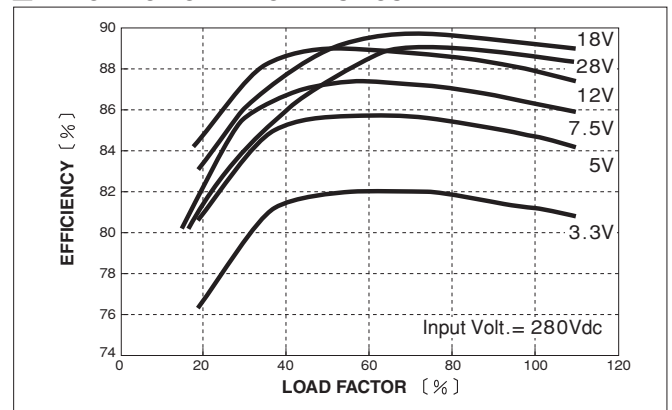



# DBS700B

DB S 700 B 28 -□

① ② ③ ④ ⑤ ⑥

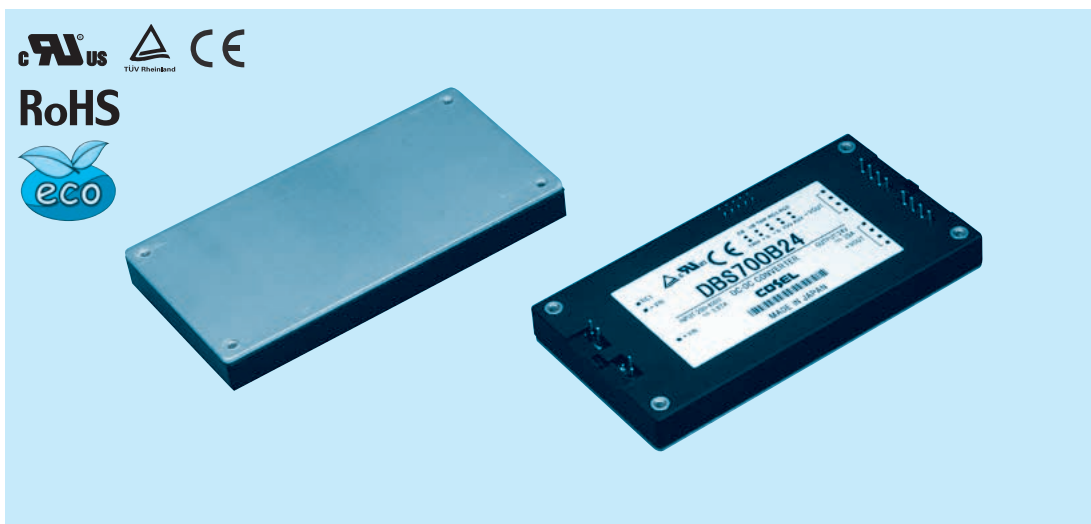

- ① Series name
- ② Single output
- ③ Output wattage
- ④ Input voltage  
B : DC200 - 400V
- ⑤ Output voltage
- ⑥ Optional  
T : with Mounting hole  
(φ 3.4 thru)

| MODEL                 | DBS700B12 | DBS700B24 | DBS700B28 | DBS700B36 | DBS700B48 |
|-----------------------|-----------|-----------|-----------|-----------|-----------|
| MAX OUTPUT WATTAGE[W] | 696       | 696       | 700       | 702       | 696       |
| DC OUTPUT             | 12V 58A   | 24V 29A   | 28V 25A   | 36V 19.5A | 48V 14.5A |

## SPECIFICATIONS

|                                    | MODEL   | DBS700B12  | DBS700B24      | DBS700B28      | DBS700B36      | DBS700B48      |        |
|------------------------------------|---|--|----------------|----------------|----------------|----------------|--------|
| INPUT                              | VOLTAGE[V]  | DC200 - 400  |                |                |                |                |        |
|                                    | CURRENT[A]  | *1 2.76typ   | 2.76typ        | 2.76typ        | 2.76typ        | 2.73typ        |        |
|                                    | EFFICIENCY[%]   | *1 90.0typ   | 90.0typ        | 90.5typ        | 90.0typ        | 91.0typ        |        |
| OUTPUT                             | VOLTAGE[V]  | 12   | 24             | 28             | 36             | 48             |        |
|                                    | CURRENT[A]  | 58   | 29             | 25             | 19.5           | 14.5           |        |
|                                    | LINE REGULATION[mV]   | 40max  | 95max          | 95max          | 95max          | 120max         |        |
|                                    | LOAD REGULATION[mV]   | 100max   | 190max         | 190max         | 200max         | 240max         |        |
|                                    | RIPPLE[mVp-p]   | 0 to +100°C*2  | 120max         | 120max         | 120max         | 150max         | 200max |
|                                    |   | -40 to 0°C*2   | 160max         | 160max         | 160max         | 200max         | 250max |
|                                    | RIPPLE NOISE[mVp-p]   | 0 to +100°C*2  | 150max         | 150max         | 150max         | 200max         | 250max |
|                                    |   | -40 to 0°C*2   | 180max         | 180max         | 180max         | 240max         | 400max |
|                                    | TEMPERATURE REGULATION[mV]  | 0 to +65°C   | 120max         | 280max         | 280max         | 360max         | 480max |
|                                    |   | -40 to +100°C  | 200max         | 480max         | 480max         | 680max         | 960max |
| DRIFT[mV]                          | *3 40max  | 90max  | 90max          | 120max         | 180max         |                |        |
| START-UP TIME[ms]                  | 200max (DCIN 280V, Io=100%)   |  |                |                |                |                |        |
| OUTPUT VOLTAGE ADJUSTMENT RANGE *4 | Fixed (TRM pin open), 60 - 110% adjustable by external VR or external voltage |  |                |                |                |                |        |
| OUTPUT VOLTAGE SETTING[V]          | 11.64 - 12.36   | 23.28 - 24.72  | 27.16 - 28.84  | 34.92 - 37.08  | 46.56 - 49.44  |                |        |
| PROTECTION CIRCUIT AND OTHERS      | OVERCURRENT PROTECTION  | Works over 105% of rating and recovers automatically   |                |                |                |                |        |
|                                    | OVERVOLTAGE PROTECTION  | 14.40 - 16.80V   | 27.60 - 33.60V | 32.20 - 39.20V | 41.40 - 50.40V | 55.20 - 63.00V |        |
|                                    | REMOTE SENSING  | Provided   |                |                |                |                |        |
|                                    | REMOTE ON/OFF   | Provided (On both side of input and output)  |                |                |                |                |        |
| ISOLATION                          | INPUT-OUTPUT  | AC3,000V 1minute, Cutoff current = 10mA, DC500V 50MΩ min (20±15°C)   |                |                |                |                |        |
|                                    | INPUT-FG  | AC2,000V 1minute, Cutoff current = 10mA, DC500V 50MΩ min (20±15°C)   |                |                |                |                |        |
|                                    | OUTPUT-FG   | AC500V 1minute, Cutoff current = 100mA, DC500V 50MΩ min (20±15°C)  |                |                |                |                |        |
|                                    | OUTPUT-RC2,RC3  | AC100V 1minute, Cutoff current = 100mA, DC100V 10MΩ min (20±15°C)  |                |                |                |                |        |
| ENVIRONMENT                        | OPERATING TEMP.,HUMID.AND ALTITUDE  | -40 to +100°C (On aluminum base plate), 20 - 95%RH (Non condensing) (Refer to "Derating"), 3,000m (10,000feet) max |                |                |                |                |        |
|                                    | STORAGE TEMP.,HUMID.AND ALTITUDE  | -40 to +100°C, 20 - 95%RH (Non condensing), 9,000m (30,000feet) max  |                |                |                |                |        |
|                                    | VIBRATION   | 10 - 55Hz, 49.0m/s <sup>2</sup> , 3minutes period, 60minutes each along X, Y and Z axis                            |                |                |                |                |        |
|                                    | IMPACT  | 196.1m/s <sup>2</sup> , 11ms once each along X, Y and Z axis   |                |                |                |                |        |
| SAFETY                             | AGENCY APPROVALS  | UL60950-1, C-UL, EN60950-1, EN50178  |                |                |                |                |        |
| OTHERS                             | CASE SIZE/WEIGHT  | 61 × 12.7 × 116.8mm [2.4 × 0.5 × 4.6 inches] (W×H×D) / 180g max  |                |                |                |                |        |
|                                    | COOLING METHOD  | Conduction cooling (e.g. heat radiation from the aluminum base plate to the attached heat sink)                    |                |                |                |                |        |

\*1 At rated input(DC280V) and rated load.

\*2 Ripple and ripple noise is measured by using measuring board with the recommended capacitor Co & the film capacitor 0.1 μF. Refer to the manual.

\*3 Drift is the change in DC output for an eight hour period after a half-hour warm-up at 25°C, with the input voltage held constant at the rated input/output.

\*4 Refer to the manual for the input range.

## External view

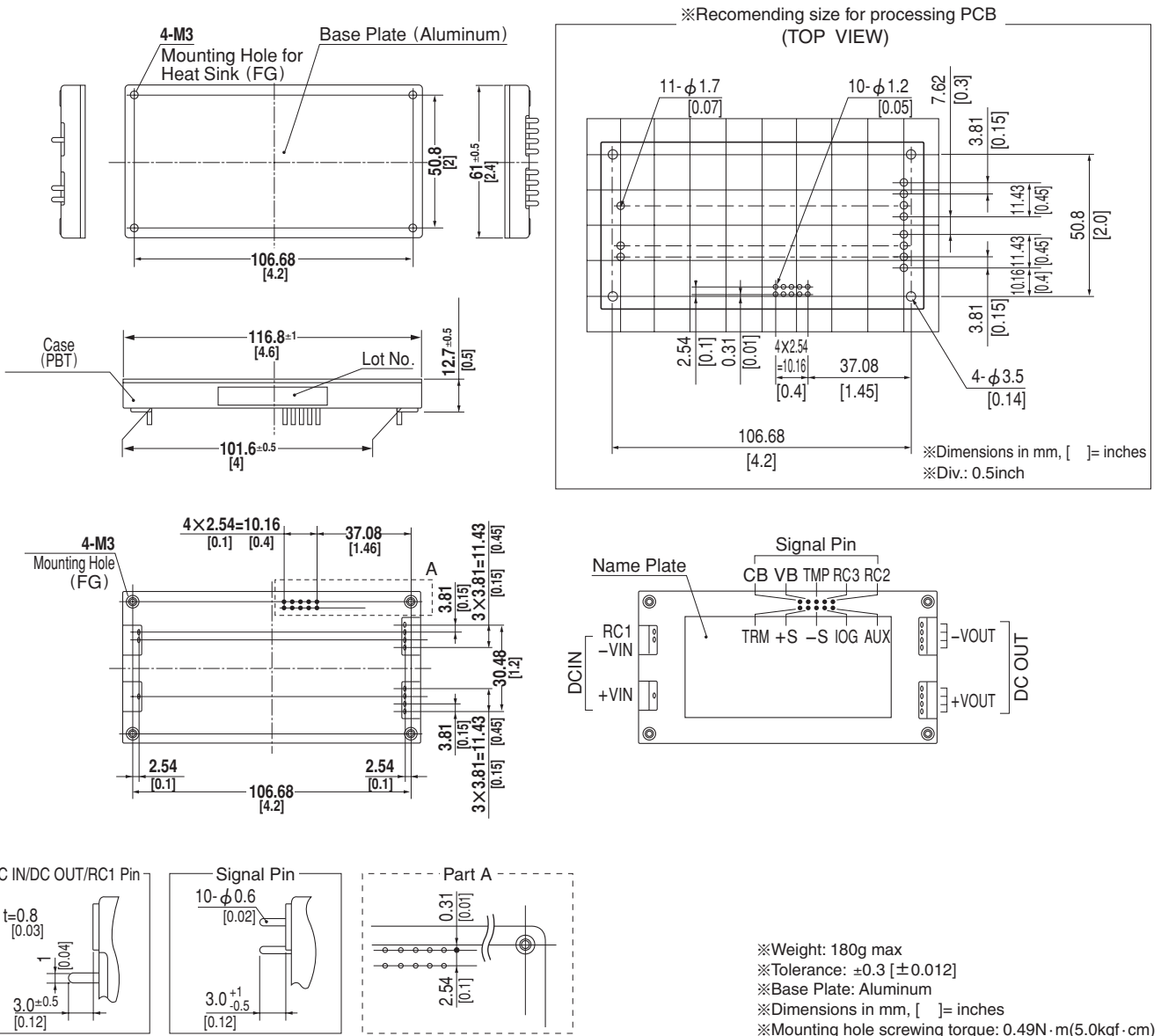

## Performance data

### INPUT CURRENT CHARACTERISTICS (DBS700B28)

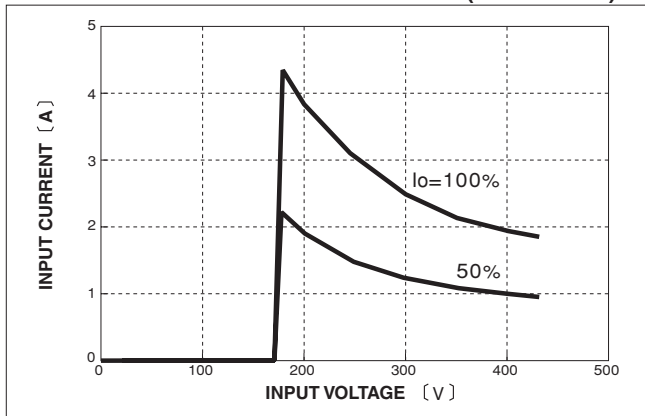

### EFFICIENCY CHARACTERISTICS (DBS700B28)

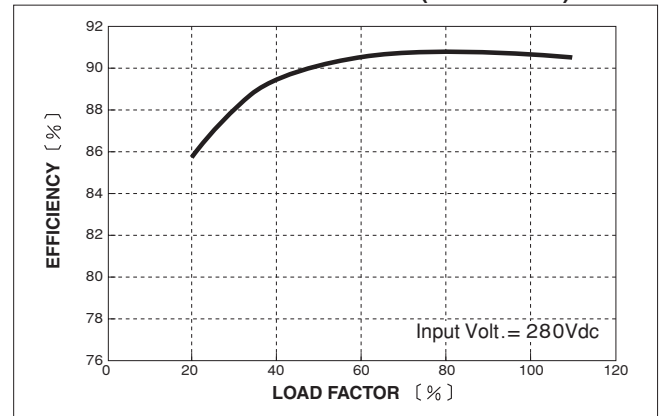

## Pin Configuration

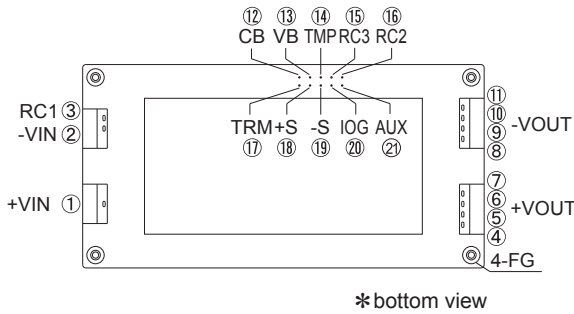

| NO.     | Pin Connection | Function                     |
|---------|----------------|------------------------------|
| ①       | +VIN           | +DC input                    |
| ②       | -VIN           | -DC input                    |
| ③       | RC1            | Remote ON/OFF(Input side)    |
| ④ ⑤ ⑥ ⑦ | +VOUT          | +DC output                   |
| ⑧ ⑨ ⑩ ⑪ | -VOUT          | -DC output                   |
| ⑫       | CB             | Current balance              |
| ⑬       | VB             | Voltage balance              |
| ⑭       | TMP            | Thermal detection signal     |
| ⑮       | RC3            | Remote ON/OFF(output side)   |
| ⑯       | RC2            |                              |
| ⑰       | TRM            | Adjustment of output voltage |
| ⑱       | +S             | +Remote sensing              |
| ⑲       | -S             | -Remote sensing              |
| ⑳       | IOG            | Inverter operation monitor   |
| ㉑       | AUX            | Auxiliary power supply       |
| —       | FG             | Mounting hole(FG)            |

## Implementation • Mounting Method

### Mounting method

- The unit can be mounted in any direction. When two or more power supplies are used side by side, position them with proper intervals to allow enough air ventilation. Aluminum base plate temperature around each power supply should not exceed the temperature range shown in "Derating".
- Avoid placing the DC input line pattern lay out underneath the unit, it will increase the line conducted noise. Make sure to leave an ample distance between the line pattern lay out and the unit. Also avoid placing the DC output line pattern underneath the unit because it may increase the output noise. Lay out the pattern away from the unit.
- High-frequency noise radiates directly from the unit to the atmosphere. Therefore, design the shield pattern on the printed circuit board and connect its one to FG. The shield pattern prevents noise radiation.

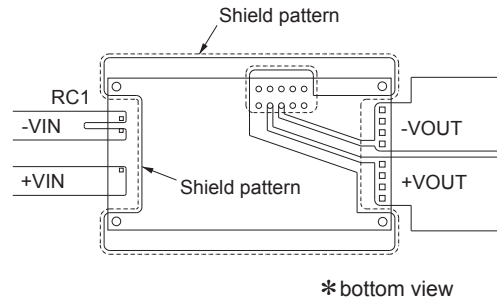

### Stress onto the pins

- When too much stress is applied to the pins of the power supply, the internal connection may be weakened. As shown in right figure avoid applying stress of more than 29.4N (3kgf) on the input pins/output pins (A part) and more than 9.8N (1kgf) to the signal pins (B part).
- The pins are soldered on PCB internally, therefore, do not pull or bend them with abnormal forces.
- Mounting hole diameter of PCB should be 3.5mm to reduce the stress onto the pins.
- Fix the unit on PCB(fixing fittings) by screws to reduce the stress onto the pins. Be sure to mount the unit first, then solder the unit.

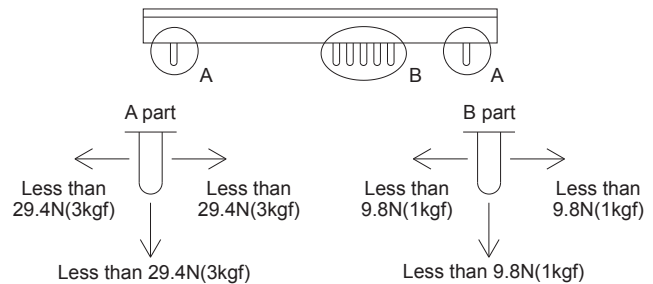

### Soldering temperature

- Flow soldering : 260°C less than 15 seconds.
- Soldering iron
  - DC IN/DC OUT/RC1 : 450°C less than 5 seconds.
  - Signal pins : 350°C less than 3 seconds (less than 20W)

### Derating

- Use with the conduction cooling (e.g. heat radiation by conduction from the aluminum base plate to the attached heat sink). Below shows the derating curve based on the aluminum base plate temperature. In the hatched area, the specification of ripple and ripple noise is different from other areas.
- It is necessary to note thermal fatigue life by power cycle. Please reduce the temperature fluctuation range as much as possible when the up and down of temperature are frequently generated. Contact for more information on cooling methods.

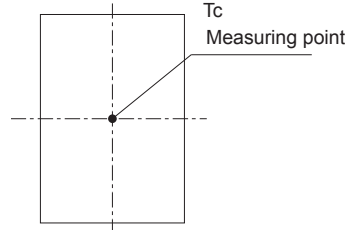
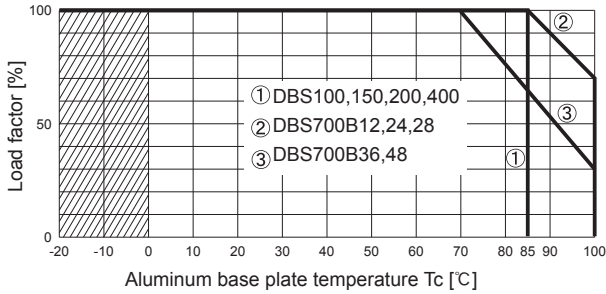

### Instruction Manual

- ◆ It is necessary to read the "Instruction Manual" and "Before using our product" before you use our product.

Instruction Manual <https://en.cosel.co.jp/product/powersupply/DBS/>  
 Before using our product <https://en.cosel.co.jp/technical/caution/index.html>

DBS



NOTICE



### Basic Characteristics Data

| Model   | Circuit method    | Switching frequency [kHz] | Input current [A] | Rated input fuse | Inrush current protection | PCB/Pattern |              |              | Series/Parallel operation availability |                    |
|---------|-------------------|---------------------------|-------------------|------------------|---------------------------|-------------|--------------|--------------|--|--------------------|
|         |                   |                           |                   |                  |                           | Material    | Single sided | Double sided | Series operation                       | Parallel operation |
| DBS100A | Forward converter | 370                       | 1.10 *1           | -                | -                         | Aluminum    | Yes          |              | Yes                                    | Yes                |
| DBS150A | Forward converter | 370                       | 1.59 *1           | -                | -                         | Aluminum    | Yes          |              | Yes                                    | Yes                |
| DBS200B | Forward converter | 370                       | 0.99 *1           | -                | -                         | Aluminum    | Yes          |              | Yes                                    | Yes                |
| DBS400B | Forward converter | 370                       | 1.72 *1           | -                | -                         | Aluminum    | Yes          |              | Yes                                    | Yes                |
| DBS700B | Forward converter | 381                       | 2.76 *1           | -                | -                         | Aluminum    | Yes          |              | Yes                                    | Yes                |

\*1 The value of input current is at rated input and rated load.