

COSEL|科索 LEB225F-0524 **PDF**

COSEL

深圳创唯电子有限公司

<http://www.cosef.net>

LEB100F

LEB 100 F -05 24 -□

① ② ③ ④ ⑤ ⑥

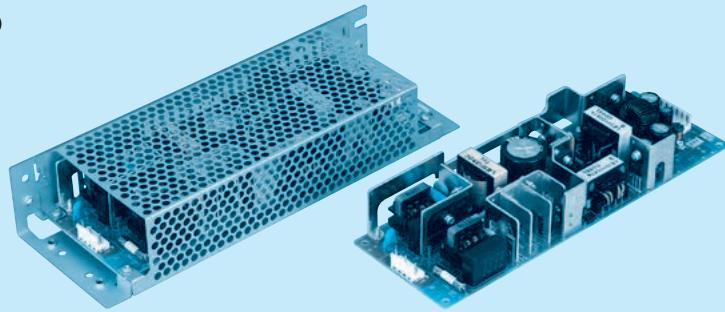

Example recommended EMI/EMC filter
NAC-06-472



High voltage pulse noise type : NAP series
Low leakage current type : NAM series
* A higher current rating EMI/EMC filter may be recommended in view of the other devices that could be connected in parallel with the power supply.

- ① Series name
- ② Output wattage
- ③ Universal input
- ④ V1 Output voltage
- ⑤ V2 Output voltage
- ⑥ Optional *1 *8
- G : Low leakage current
- R : with Remote ON/OFF
- S : with Chassis
- SN : with Chassis & cover
- T : Vertical terminal block
- Y : with Potentiometer
- Z : with ZT

*Make sure necessary tests will be carried out on your end equipment with the power supply installed in accordance with any required EMC/EMI regulations.

MODEL	LEB100F-0512	LEB100F-0324	LEB100F-0524	LEB100F-0530	LEB100F-0536
DC OUTPUT	V1	+5V 5A	+3.3V 5A	+5V 5A	+5V 5A
	V2	+12V 5(Peak 10)A	+24V 4(Peak 7)A	+24V 4(Peak 7)A	+30V 3.2(Peak 5.6)A

SPECIFICATIONS

	MODEL	LEB100F-0512	LEB100F-0324	LEB100F-0524	LEB100F-0530	LEB100F-0536						
INPUT	VOLTAGE[V]	AC85 - 264 1 φ or DC 120 - 370										
	CURRENT[A]	ACIN 100V	1.2typ (Io=100%)	1.4typ (Io=100%)								
		ACIN 200V	0.6typ (Io=100%)	0.7typ (Io=100%)								
	FREQUENCY[Hz]	50/60 (47 - 63) or DC										
	EFFICIENCY[%]	ACIN 100V	74typ (Io=100%)	78typ (Io=100%)	78typ (Io=100%)	78typ (Io=100%)	78typ (Io=100%)					
		ACIN 200V	76typ (Io=100%)	80typ (Io=100%)	80typ (Io=100%)	80typ (Io=100%)	80typ (Io=100%)					
	POWER FACTOR	ACIN 100V	0.98typ	0.99typ								
		ACIN 200V	0.93typ									
	INRUSH CURRENT[A]	ACIN 100V	15typ (Io=100%) (At cold start) (Ta=25°C)									
		ACIN 200V	30typ (Io=100%) (At cold start) (Ta=25°C)									
LEAKAGE CURRENT[mA]	0.75max (60Hz, According to IEC60950 and DEN-AN)											
OUTPUT	VOLTAGE[V]	+5	+12	+3.3	+24	+5	+30	+5	+36			
	CURRENT[A]	*2 0 - 5	0 - 5 (Peak 10)	0 - 5	0 - 4 (Peak 7)	0 - 5	0 - 4 (Peak 7)	0 - 5	0 - 3.2 (Peak 5.6)	0 - 5	0 - 2.7 (Peak 4.7)	
	TOTAL OUTPUT WATTAGE[W]	*3 85 (Peak 145)	100 (Peak 172)		100 (Peak 172)		100 (Peak 172)		100 (Peak 172)			
	LINE REGULATION[mV]	20max	48max	20max	96max	20max	96max	20max	120max	20max	144max	
		40max	100max	40max	150max	40max	150max	40max	180max	40max	180max	
	LOAD REGULATION[mV]	20max	48max	20max	96max	20max	96max	20max	120max	20max	144max	
		40max	100max	40max	150max	40max	150max	40max	180max	40max	180max	
	RIPPLE[mVp-p]	0 to +50°C *4	80max	120max	80max	120max	80max	120max	80max	200max	80max	200max
		-10 - 0°C *4	140max	160max	140max	160max	140max	160max	140max	240max	140max	240max
	RIPPLE NOISE[mVp-p]	0 to +50°C *4	120max	150max	120max	150max	120max	150max	120max	300max	120max	300max
		-10 - 0°C *4	160max	180max	160max	180max	160max	180max	160max	360max	160max	360max
	TEMPERATURE REGULATION[mV]	0 to +50°C	50max	120max	50max	240max	50max	240max	50max	300max	50max	300max
		-10 to +50°C	60max	150max	60max	290max	60max	290max	60max	350max	60max	350max
	DRIFT[mV]	*5 20max	48max	20max	96max	20max	96max	20max	120max	20max	144max	
	START-UP TIME[ms]	*6 250max	500max	250max	500max	250max	500max	250max	500max	250max	500max	
	HOLD-UP TIME[ms]	*6 40typ	20typ	40typ	20typ	40typ	20typ	40typ	20typ	40typ	20typ	
OUTPUT VOLTAGE ADJUSTMENT RANGE[V]	*6 4.5 - 5.5	Fixed	2.85 - 3.60	Fixed	4.5 - 5.5	Fixed	4.5 - 5.5	Fixed	4.5 - 5.5	Fixed		
OUTPUT VOLTAGE SETTING[V]	—	11.5 - 12.5	—	23.0 - 25.0	—	23.0 - 25.0	—	28.7 - 31.5	—	34.5 - 37.5		
PROTECTION CIRCUIT AND OTHERS	OVERCURRENT PROTECTION	V1	Works over 105% of rating current and recovers automatically									
		V2	Works over 101% of peak current and recovers automatically									
	OVERVOLTAGE PROTECTION	V1	Works over 115% of rating, by zener diode clamping									
		V2	Works at 115 - 140% of rating									
REMOTE ON/OFF	Option (Refer to Instruction Manual)											
ISOLATION	INPUT-OUTPUT · RC	*7 AC3.000V 1minute, Cutoff current = 10mA, DC500V 50MΩ min (At Room Temperature)										
	INPUT-FG	AC2.000V 1minute, Cutoff current = 10mA, DC500V 50MΩ min (At Room Temperature)										
	OUTPUT · RC-FG	*7 AC500V 1minute, Cutoff current = 100mA, DC500V 50MΩ min (At Room Temperature)										
OUTPUT-OUTPUT(V1 · RC-V2)	*7 AC100V 1minute, Cutoff current = 100mA, DC100V 10MΩ min (At Room Temperature)											
ENVIRONMENT	OPERATING TEMP., HUMID. AND ALTITUDE	-10 to +70°C, 20 - 90%RH (Non condensing) (Refer to DERATING CURVE), 3,000m (10,000feet) max										
	STORAGE TEMP., HUMID. AND ALTITUDE	-20 to +75°C, 20 - 90%RH (Non condensing), 9,000m (30,000feet) max										
	VIBRATION	10 - 55Hz, 19.6m/s ² (2G), 3minutes period, 60minutes each along X, Y and Z axis										
SAFETY AND NOISE REGULATIONS	AGENCY APPROVALS	UL60950-1, C-UL, EN60950-1, EN50178 Complies with DEN-AN and IEC60950-1 (At only AC input)										
	CONDUCTED NOISE	Complies with FCC-B, CISPR22-B, EN55022-B, VCCI-B										
	HARMONIC ATTENUATOR	Complies with IEC61000-3-2 *9										
OTHERS	CASE SIZE/WEIGHT	75 × 35 × 222mm [2.95 × 1.38 × 8.74 inches] (W × H × D) /420g max (with chassis & cover : 690g max)										
	COOLING METHOD	Convection										

*1 Specification is changed at option, refer to Instruction Manual 5.
 *2 Peak loading for 10sec. And Duty 35% max, refer to Instruction Manual 4. In detail.
 *3 Refer to Instruction Manual 2.2 in detail.
 *4 This is the value that measured on measuring board with capacitor of 22 μF within 150mm from output terminal. Measured by 20MHz oscilloscope or Ripple-Noise meter (Equivalent to KEISOKU-GIKEN: RM101).
 *5 Drift is the change in DC output for an eight hour period after a half-hour warm-up at 25°C, with the input voltage held constant at the rated input/output.

*6 ACIN 100V, Io=100%
 *7 Applicable when remote control (optional) is added.
 *8 Please contact us about safety approvals for the model with option.
 *9 Please contact us about class C.
 * Series/Parallel operation is not possible.
 * Derating is required when operated with chassis and cover.
 * A sound may occur from power supply at peak loading.

External view

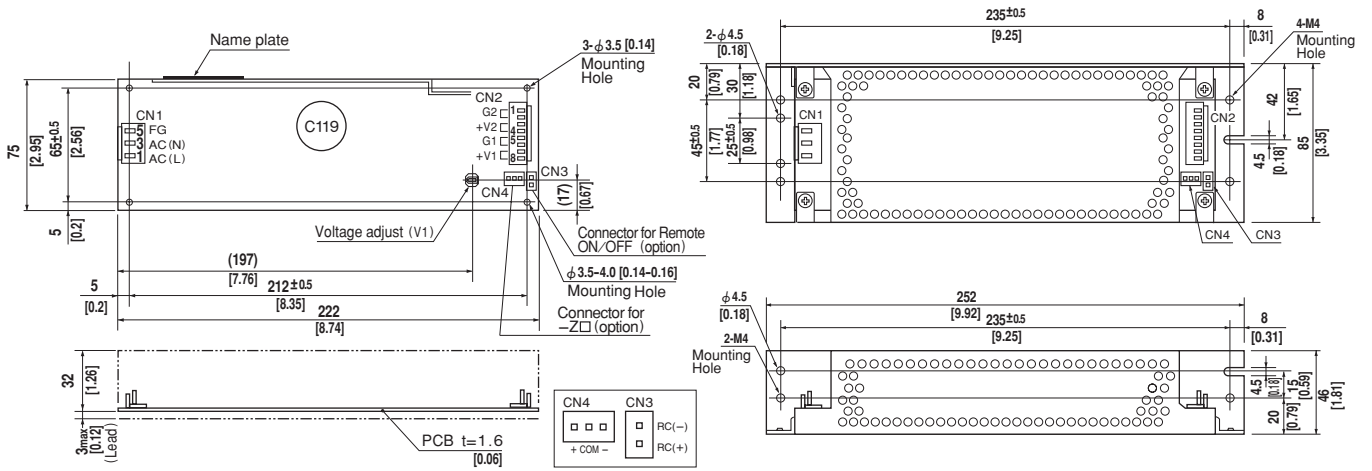

I / O Connector	Mating Connector	Terminal
CN1	B3P5-VH	VHR-5N
CN2	B8P-VH	VHR-8N
CN3 (Option)	B2B-XH-A	XHP-2
CN4 (Option)	B3B-XH-A	XHP-3

CN1

Pin No.	Input
1	AC(L)
2	AC(N)
3	AC(N)
4	AC(N)
5	FG

(PIN CONNECTION)

CN2

Pin No.	Output
1, 2	G 2
3, 4	V 2
5, 6	G 1
7, 8	V 1

CN3 (Option)

Pin No.	Remote ON/OFF
1	RC(+)
2	RC(-)

CN4 (Option)

Pin No.	-Z□
1	+
2	COM
3	-

- ※Weight: 420g max (with chassis & cover : 690g max)
- ※Tolerance: ±1 [±0.04]
- ※Dimensions in mm, [] = inches
- ※PCB Material : CEM3
- ※Chassis and cover is optional.
- ※Mounting torque: 1.5N · m(16kgf · cm)max

(Mfr: J.S.T.)

※Keep drawing current per pin below 5A for CN2

Performance data

RISE TIME & FALL TIME (LEB100F-0524)

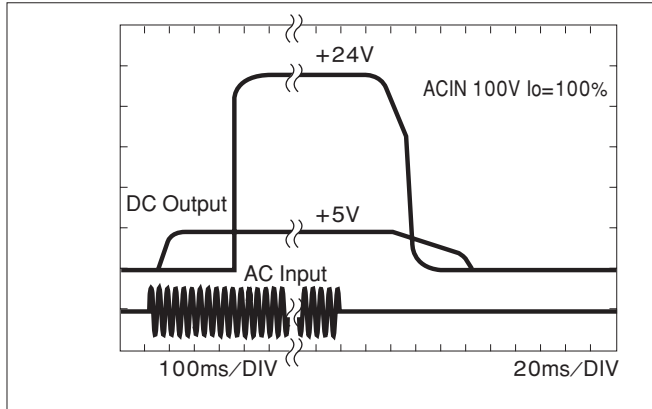

EFFICIENCY (LEB100F-0524)

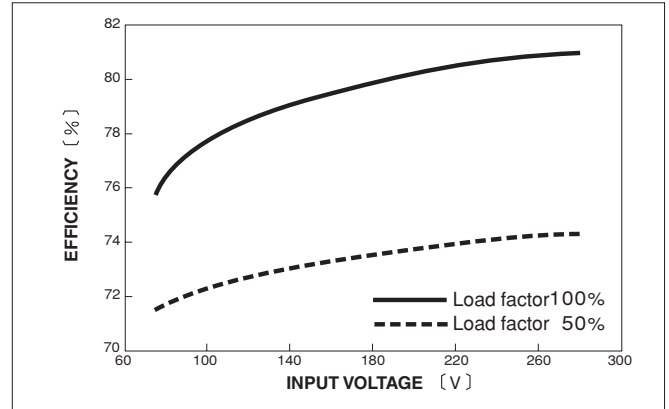

INPUT HARMONIC CURRENT (LEB100F-0524)

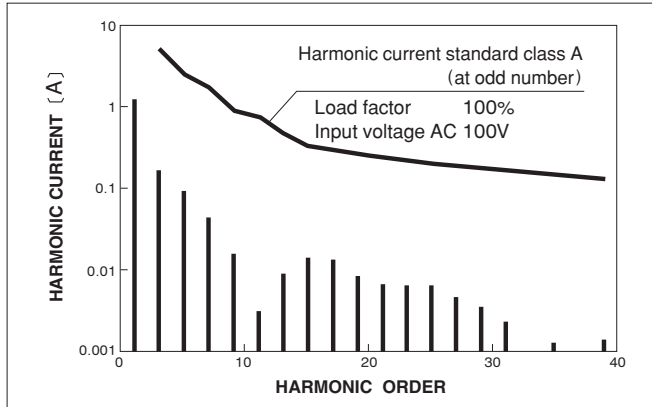

INPUT HARMONIC CURRENT (LEB100F-0524)

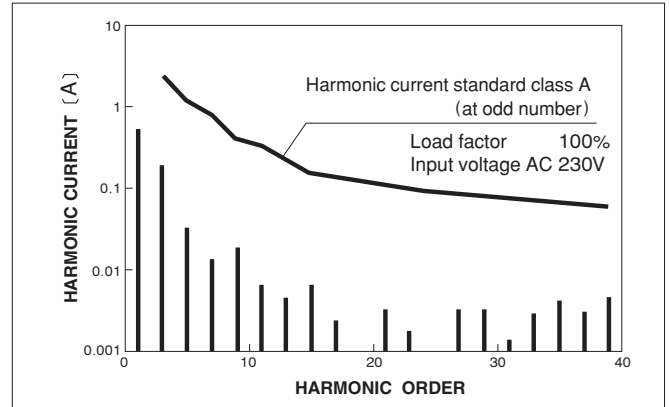

LEB150F

LEB 150 F -05 24 -□

① ② ③ ④ ⑤ ⑥

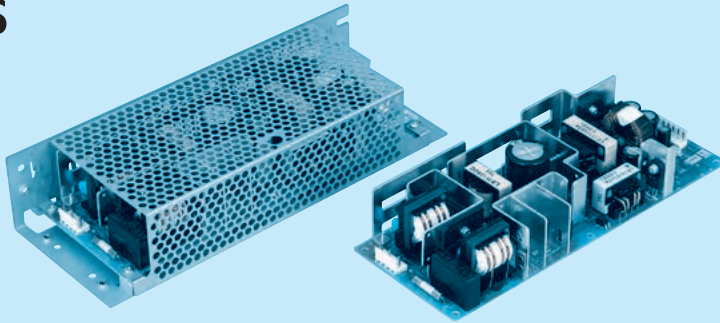

Example recommended EMI/EMC filter
NAC-06-472



High voltage pulse noise type : NAP series
Low leakage current type : NAM series
* A higher current rating EMI/EMC filter may be recommended in view of the other devices that could be connected in parallel with the power supply.

- ① Series name
- ② Output wattage
- ③ Universal input
- ④ V1 Output voltage
- ⑤ V2 Output voltage
- ⑥ Optional *1 *8
- G : Low leakage current
- R : with Remote ON/OFF
- S : with Chassis
- SN : with Chassis & cover
- T : Vertical terminal block
- Y : with Potentiometer
- Z : with ZT

*Make sure necessary tests will be carried out on your end equipment with the power supply installed in accordance with any required EMC/EMI regulations.

MODEL	LEB150F-0512	LEB150F-0324	LEB150F-0524	LEB150F-0530	LEB150F-0536
DC OUTPUT	V1	+5V 5A	+3.3V 5A	+5V 5A	+5V 5A
	V2	+12V 7.5(Peak 14)A	+24V 6(Peak 10)A	+24V 6(Peak 10)A	+30V 4.8(Peak 8)A

SPECIFICATIONS

	MODEL	LEB150F-0512	LEB150F-0324	LEB150F-0524	LEB150F-0530	LEB150F-0536						
INPUT	VOLTAGE[V]	AC85 - 264 1 φ or DC 120 - 370										
	CURRENT[A]	ACIN 100V	1.6typ (Io=100%)	1.0typ (Io=100%)		2.0typ (Io=100%)						
		ACIN 200V	0.8typ (Io=100%)	1.0typ (Io=100%)		1.0typ (Io=100%)						
	FREQUENCY[Hz]	50/60 (47 - 63) or DC										
	EFFICIENCY[%]	ACIN 100V	76typ (Io=100%)	79typ (Io=100%)	79typ (Io=100%)	79typ (Io=100%)	79typ (Io=100%)					
		ACIN 200V	79typ (Io=100%)	82typ (Io=100%)	82typ (Io=100%)	82typ (Io=100%)	82typ (Io=100%)					
	POWER FACTOR	ACIN 100V	0.98typ	0.99typ								
		ACIN 200V	0.93typ									
	INRUSH CURRENT[A]	ACIN 100V	15typ (Io=100%) (At cold start) (Ta=25°C)									
		ACIN 200V	30typ (Io=100%) (At cold start) (Ta=25°C)									
LEAKAGE CURRENT[mA]	0.75max (60Hz, According to IEC60950 and DEN-AN)											
OUTPUT	VOLTAGE[V]	+5	+12	+3.3	+24	+5	+30	+5	+36			
	CURRENT[A]	*2 0 - 5	0 - 7.5 (Peak 14)	0 - 5	0 - 6 (Peak 10)	0 - 5	0 - 6 (Peak 10)	0 - 5	0 - 4 (Peak 8)	0 - 5	0 - 4 (Peak 6.7)	
	TOTAL OUTPUT WATTAGE[W]	*3 115 (Peak 193)	150 (Peak 246)		150 (Peak 246)		150 (Peak 246)		150 (Peak 246)			
	LINE REGULATION[mV]	20max	48max	20max	96max	20max	96max	20max	120max	20max	144max	
		40max	100max	40max	150max	40max	150max	40max	180max	40max	180max	
	LOAD REGULATION[mV]	20max	48max	20max	96max	20max	96max	20max	120max	20max	144max	
		40max	100max	40max	150max	40max	150max	40max	180max	40max	180max	
	RIPPLE[mVp-p]	0 to +45°C *4	80max	120max	80max	120max	80max	120max	80max	200max	80max	200max
		-10 - 0°C *4	140max	160max	140max	160max	140max	160max	140max	240max	140max	240max
	RIPPLE NOISE[mVp-p]	0 to +45°C *4	120max	150max	120max	150max	120max	150max	120max	300max	120max	300max
		-10 - 0°C *4	160max	180max	160max	180max	160max	180max	160max	360max	160max	360max
	TEMPERATURE REGULATION[mV]	0 to +45°C	50max	120max	50max	240max	50max	240max	50max	300max	50max	300max
		-10 to +45°C	60max	150max	60max	290max	60max	290max	60max	350max	60max	350max
	DRIFT[mV]	*5 20max	48max	20max	96max	20max	96max	20max	120max	20max	144max	
	START-UP TIME[ms]	*6 250max	500max	250max	500max	250max	500max	250max	500max	250max	500max	
HOLD-UP TIME[ms]	*6 40typ	20typ	40typ	20typ	40typ	20typ	40typ	20typ	40typ	20typ		
OUTPUT VOLTAGE ADJUSTMENT RANGE[V]	*6 4.5 - 5.5	Fixed	2.85 - 3.60	Fixed	4.5 - 5.5	Fixed	4.5 - 5.5	Fixed	4.5 - 5.5	Fixed		
OUTPUT VOLTAGE SETTING[V]	—	11.5 - 12.5	—	23.0 - 25.0	—	23.0 - 25.0	—	28.7 - 31.5	—	34.5 - 37.5		
PROTECTION CIRCUIT AND OTHERS	OVERCURRENT PROTECTION	V1	Works over 105% of rating current and recovers automatically									
		V2	Works over 101% of peak current and recovers automatically									
	OVERVOLTAGE PROTECTION	V1	Works over 115% of rating, by zener diode clamping									
		V2	Works at 115 - 140% of rating									
REMOTE ON/OFF	Option (Refer to Instruction Manual)											
ISOLATION	INPUT-OUTPUT · RC	*7 AC3.000V 1minute, Cutoff current = 10mA, DC500V 50MΩ min (At Room Temperature)										
	INPUT-FG	AC2.000V 1minute, Cutoff current = 10mA, DC500V 50MΩ min (At Room Temperature)										
	OUTPUT · RC-FG	*7 AC500V 1minute, Cutoff current = 100mA, DC500V 50MΩ min (At Room Temperature)										
	OUTPUT-OUTPUT(V1 · RC-V2)	*7 AC100V 1minute, Cutoff current = 100mA, DC100V 10MΩ min (At Room Temperature)										
ENVIRONMENT	OPERATING TEMP., HUMID. AND ALTITUDE	-10 to +70°C, 20 - 90%RH (Non condensing) (Refer to DERATING CURVE), 3,000m (10,000feet) max										
	STORAGE TEMP., HUMID. AND ALTITUDE	-20 to +75°C, 20 - 90%RH (Non condensing), 9,000m (30,000feet) max										
	VIBRATION	10 - 55Hz, 19.6m/s ² (2G), 3minutes period, 60minutes each along X, Y and Z axis										
SAFETY AND NOISE REGULATIONS	AGENCY APPROVALS	UL60950-1, C-UL, EN60950-1, EN50178 Complies with DEN-AN and IEC60950-1 (At only AC input)										
	CONDUCTED NOISE	Complies with FCC-B, CISPR22-B, EN55022-B, VCCI-B										
	HARMONIC ATTENUATOR	Complies with IEC61000-3-2 *9										
OTHERS	CASE SIZE/WEIGHT	85 × 40 × 222mm [3.35 × 1.57 × 8.74 inches] (W × H × D) /530g max (with chassis & cover : 870g max)										
	COOLING METHOD	Convection										

*1 Specification is changed at option, refer to Instruction Manual 5.
 *2 Peak loading for 10sec. And Duty 35% max, refer to Instruction Manual 4. In detail.
 *3 Refer to Instruction Manual 2.2 in detail.
 *4 This is the value that measured on measuring board with capacitor of 22 μF within 150mm from output terminal. Measured by 20MHz oscilloscope or Ripple-Noise meter (Equivalent to KEISOKU-GIKEN: RM101).
 *5 Drift is the change in DC output for an eight hour period after a half-hour warm-up at 25°C, with the input voltage held constant at the rated input/output.

*6 ACIN 100V, Io=100%
 *7 Applicable when remote control (optional) is added.
 *8 Please contact us about safety approvals for the model with option.
 *9 Please contact us about class C.
 * Series/Parallel operation is not possible.
 * Derating is required when operated with chassis and cover.
 * A sound may occur from power supply at peak loading.

External view

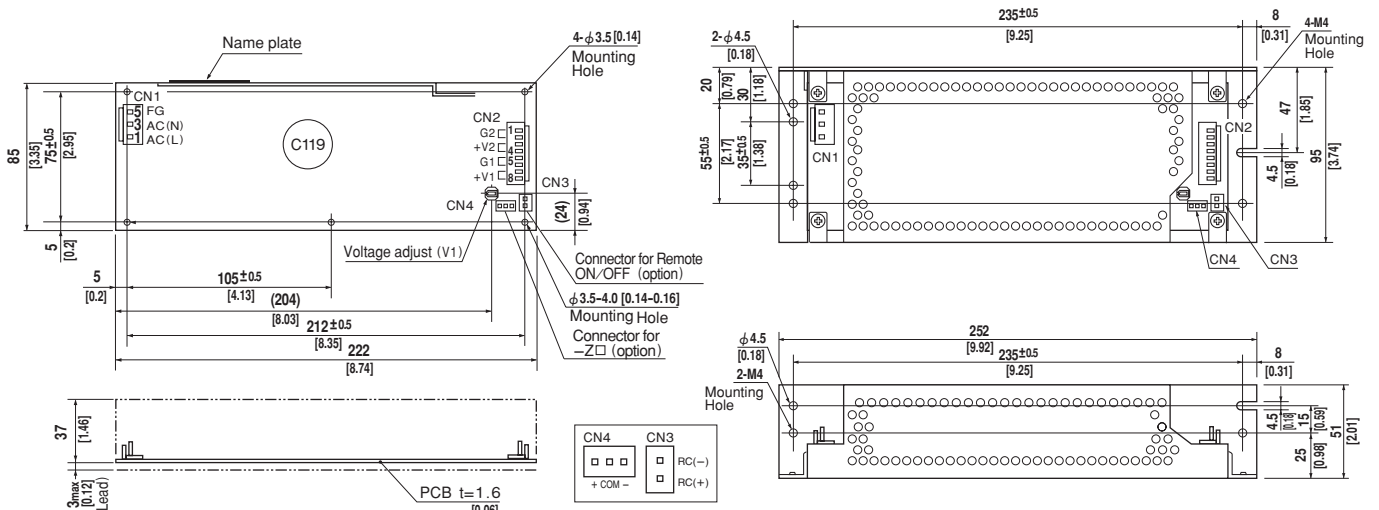

(PIN CONNECTION)

I / O Connector	Mating Connector	Terminal
CN1	B3P5-VH	VHR-5N
CN2	B8P-VH	VHR-8N
CN3 (Option)	B2B-XH-A	XHP-2
CN4 (Option)	B3B-XH-A	XHP-3

CN1	
Pin No.	Input
1	AC(L)
2	AC(N)
3	AC(N)
4	AC(N)
5	FG

CN2	
Pin No.	Output
1, 2	G 2
3, 4	V 2
5, 6	G 1
7, 8	V 1

CN3 (Option)	
Pin No.	Remote ON/OFF
1	RC(+)
2	RC(-)

CN4 (Option)	
Pin No.	-Z □
1	+
2	COM
3	-

- ※Weight: 530g max (with chassis & cover : 870g max)
- ※Tolerance: ±1 [±0.04]
- ※Dimensions in mm, [] = inches
- ※PCB Material : CEM3
- ※Chassis and cover is optional.
- ※Mounting torque: 1.5N · m(16kgf · cm)max

(Mfr: J.S.T.)

※Keep drawing current per pin below 5A(7A at peak load)for CN2

Performance data

RISE TIME & FALL TIME (LEB150F-0524)

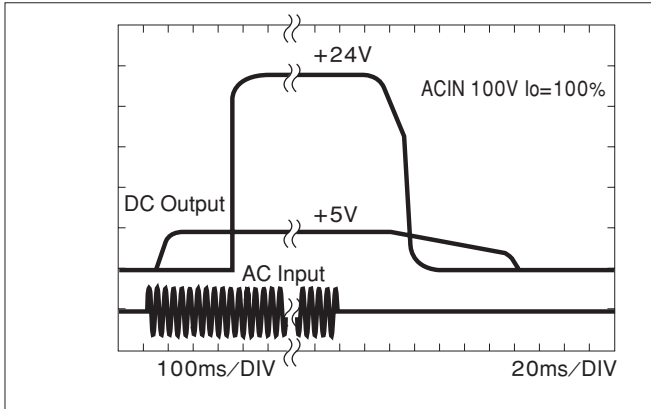

EFFICIENCY (LEB150F-0524)

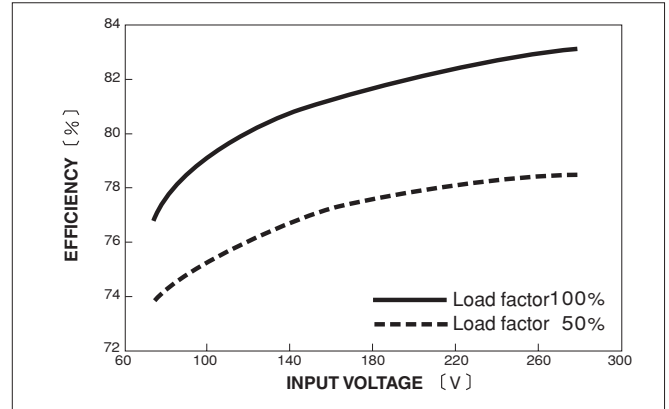

INPUT HARMONIC CURRENT (LEB150F-0524)

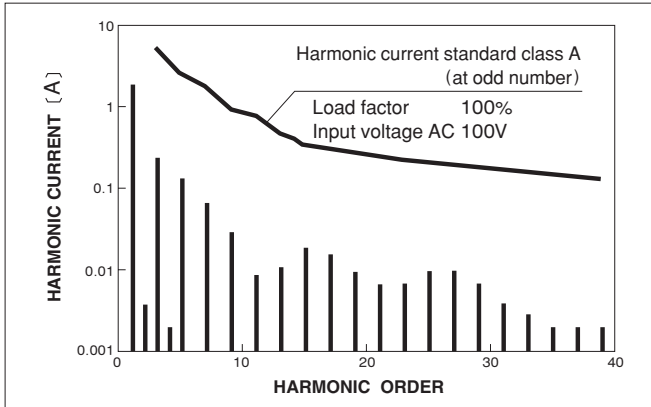

INPUT HARMONIC CURRENT (LEB150F-0524)

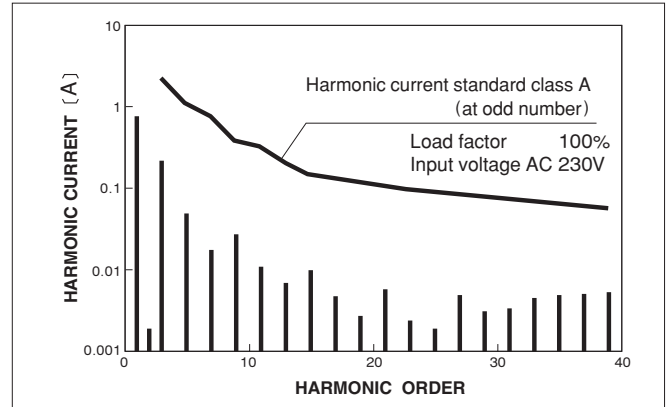

LEB225F

LEB 225 F -05 24 -□
 ① ② ③ ④ ⑤ ⑥

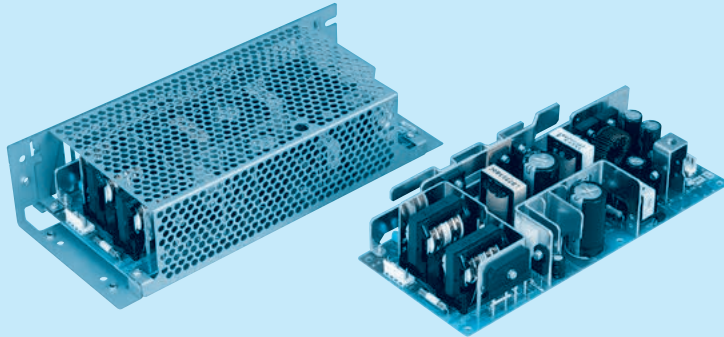

Example recommended EMI/EMC filter
NAC-06-472



High voltage pulse noise type : NAP series
 Low leakage current type : NAM series
 * A higher current rating EMI/EMC filter may be recommended in view of the other devices that could be connected in parallel with the power supply.

- ① Series name
- ② Output wattage
- ③ Universal input
- ④ V1 Output voltage
- ⑤ V2 Output voltage
- ⑥ Optional *1 *8
- G : Low leakage current
- R : with Remote ON/OFF
- S : with Chassis
- SN : with Chassis & cover
- T : Vertical terminal block
- Y : with Potentiometer
- Z : with ZT

*Make sure necessary tests will be carried out on your end equipment with the power supply installed in accordance with any required EMC/EMI regulations.

MODEL	LEB225F-0512	LEB225F-0324	LEB225F-0524	LEB225F-0530	LEB225F-0536
DC OUTPUT	V1	+5V 5A	+3.3V 5A	+5V 5A	+5V 5A
	V2	+12V 10(Peak 20)A	+24V 9(Peak 14)A	+24V 9(Peak 14)A	+30V 7.2(Peak 11)A

SPECIFICATIONS

	MODEL	LEB225F-0512	★LEB225F-0324	LEB225F-0524	LEB225F-0530	★LEB225F-0536						
INPUT	VOLTAGE[V]	AC85 - 264 1 φ or DC 120 - 370										
	CURRENT[A]	ACIN 100V	1.9typ (Io=100%)	3.0typ (Io=100%)		3.0typ (Io=100%)						
		ACIN 200V	1.0typ (Io=100%)	1.5typ (Io=100%)		1.5typ (Io=100%)						
	FREQUENCY[Hz]	50/60 (47 - 63) or DC										
	EFFICIENCY[%]	ACIN 100V	77typ (Io=100%)	81typ (Io=100%)	81typ (Io=100%)	81typ (Io=100%)	81typ (Io=100%)					
		ACIN 200V	79typ (Io=100%)	83typ (Io=100%)	83typ (Io=100%)	83typ (Io=100%)	83typ (Io=100%)					
	POWER FACTOR	ACIN 100V	0.98typ	0.99typ								
		ACIN 200V	0.93typ									
	INRUSH CURRENT[A]	ACIN 100V	15typ (Io=100%) (More than 3sec.to re-start)									
		ACIN 200V	30typ (Io=100%) (More than 3sec.to re-start)									
LEAKAGE CURRENT[mA]	0.75max (60Hz, According to IEC60950 and DEN-AN)											
OUTPUT	VOLTAGE[V]	+5	+12	+3.3	+24	+5	+30	+5	+36			
	CURRENT[A]	*2	0 - 5	0 - 10 (Peak 20)	0 - 5	0 - 9 (Peak 14)	0 - 5	0 - 9 (Peak 14)	0 - 5	0 - 6 (Peak 9.3)		
	TOTAL OUTPUT WATTAGE[W]	*3	145 (Peak 265)		225 (Peak 345)		225 (Peak 345)		225 (Peak 345)			
	LINE REGULATION[mV]	20max	48max	20max	96max	20max	96max	20max	120max	20max	144max	
		40max	100max	40max	150max	40max	150max	40max	180max	40max	180max	
	RIPPLE[mVp-p]	0 to +40°C *4	80max	120max	80max	120max	80max	120max	80max	200max	80max	200max
		-10 - 0°C *4	140max	160max	140max	160max	140max	160max	140max	240max	140max	240max
	RIPPLE NOISE[mVp-p]	0 to +40°C *4	120max	150max	120max	150max	120max	150max	120max	300max	120max	300max
		-10 - 0°C *4	160max	180max	160max	180max	160max	180max	160max	360max	160max	360max
	TEMPERATURE REGULATION[mV]	0 to +40°C	50max	120max	50max	240max	50max	240max	50max	300max	50max	300max
		-10 to +40°C	60max	150max	60max	290max	60max	290max	60max	350max	60max	350max
	DRIFT[mV]	*5	20max	48max	20max	96max	20max	96max	20max	120max	20max	144max
	START-UP TIME[ms]	*6	250max	500max	250max	500max	250max	500max	250max	500max	250max	500max
	HOLD-UP TIME[ms]	*6	40typ	20typ	40typ	20typ	40typ	20typ	40typ	20typ	40typ	20typ
	OUTPUT VOLTAGE ADJUSTMENT RANGE[V]	*6	4.5 - 5.5	Fixed	2.85 - 3.60	Fixed	4.5 - 5.5	Fixed	4.5 - 5.5	Fixed	4.5 - 5.5	Fixed
OUTPUT VOLTAGE SETTING[V]		—	11.5 - 12.5	—	23.0 - 25.0	—	23.0 - 25.0	—	28.7 - 31.5	—	34.5 - 37.5	
PROTECTION CIRCUIT AND OTHERS	OVERCURRENT PROTECTION	V1	Works over 105% of rating current and recovers automatically									
		V2	Works over 101% of peak current and recovers automatically									
	OVERVOLTAGE PROTECTION	V1	Works over 115% of rating, by zener diode clamping									
		V2	Works at 115 - 140% of rating									
REMOTE ON/OFF		Option (Refer to Instruction Manual)										
ISOLATION	INPUT-OUTPUT · RC	*7	AC3.000V 1minute, Cutoff current = 10mA, DC500V 50MΩ min (At Room Temperature)									
	INPUT-FG		AC2.000V 1minute, Cutoff current = 10mA, DC500V 50MΩ min (At Room Temperature)									
	OUTPUT · RC-FG	*7	AC500V 1minute, Cutoff current = 100mA, DC500V 50MΩ min (At Room Temperature)									
ENVIRONMENT	OUTPUT-OUTPUT(V1 · RC-V2)	*7	AC100V 1minute, Cutoff current = 100mA, DC100V 10MΩ min (At Room Temperature)									
SAFETY AND NOISE REGULATIONS	OPERATING TEMP., HUMID. AND ALTITUDE		-10 to +70°C, 20 - 90%RH (Non condensing) (Refer to DERATING CURVE), 3,000m (10,000feet) max									
	STORAGE TEMP., HUMID. AND ALTITUDE		-20 to +75°C, 20 - 90%RH (Non condensing), 9,000m (30,000feet) max									
	VIBRATION		10 - 55Hz, 19.6m/s ² (2G), 3minutes period, 60minutes each along X, Y and Z axis									
OTHERS	IMPACT		196.1m/s ² (20G), 11ms, once each X, Y and Z axis									
	AGENCY APPROVALS		UL60950-1, C-UL, EN60950-1, EN50178 Complies with DEN-AN and IEC60950-1 (At only AC input)									
	CONDUCTED NOISE		Complies with FCC-B, CISPR22-B, EN55022-B, VCCI-B									
	HARMONIC ATTENUATOR		Complies with IEC61000-3-2 *8									
	CASE SIZE/WEIGHT		95 × 45 × 222mm [3.74 × 1.77 × 8.74 inches] (W × H × D) /700g max (with chassis & cover : 1,080g max)									
	COOLING METHOD		Convection									

*1 Specification is changed at option, refer to Instruction Manual 5.
 *2 Peak loading for 10sec. And Duty 35% max, refer to Instruction Manual 4. In detail.
 *3 Refer to Instruction Manual 2.2 in detail.
 *4 This is the value that measured on measuring board with capacitor of 22 μF within 150mm from output terminal. Measured by 20MHz oscilloscope or Ripple-Noise meter (Equivalent to KEISOKU-GIKEN: RM101).
 *5 Drift is the change in DC output for an eight hour period after a half-hour warm-up at 25°C, with the input voltage held constant at the rated input/output.

*6 ACIN 100V, Io=100%
 *7 Applicable when remote control (optional) is added.
 *8 Please contact us about safety approvals for the model with option.
 *9 Please contact us about class C.
 * Series/Parallel operation is not possible.
 * Derating is required when operated with chassis and cover.
 * A sound may occur from power supply at load changing.
 * marked models are pending for safety approvals. Consult with us for delivery.

External view

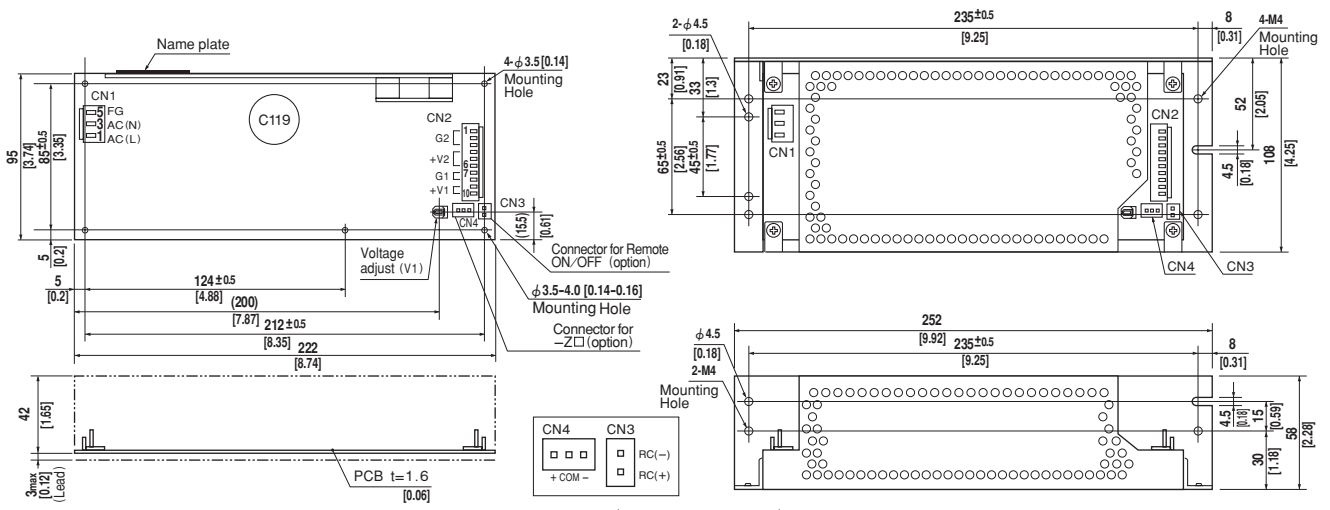

I / O Connector	Mating Connector	Terminal
CN1	B3P5-VH	VHR-5N
		Chain: SVH-21T-P1.1
		Loose: BVH-21T-P1.1
CN2	B10P-VH	VHR-10N
		Chain: SVH-21T-P1.1
		Loose: BVH-21T-P1.1
CN3 (Option)	B2B-XH-A	XHP-2
		Chain: SXH-001T-P0.6
		Loose: BXH-001T-P0.6
CN4 (Option)	B3B-XH-A	XHP-3
		Chain: SXH-001T-P0.6
		Loose: BXH-001T-P0.6

(Mfr: J.S.T.)

CN1	
Pin No.	Input
1	AC(L)
2	
3	AC(N)
4	
5	FG

(PIN CONNECTION)

CN2	
Pin No.	Output
1, 2, 3	G 2
4, 5, 6	V 2
7, 8	G 1
9, 10	V 1

CN3 (Option)	
Pin No.	Remote ON/OFF
1	RC(+)
2	RC(-)

CN4 (Option)	
Pin No.	-Z□
1	+
2	COM
3	-

- ※Weight: 700g max (with chassis & cover : 1,080g max)
- ※Tolerance: ±1 [±0.04]
- ※Dimensions in mm, [] = inches
- ※PCB Material : CEM3
- ※Chassis and cover is optional.
- ※Mounting torque: 1.5N · m(16kgf · cm)max

※Keep drawing current per pin below 5A (7A at peak load) for CN2

Performance data

RISE TIME & FALL TIME (LEB225F-0524)

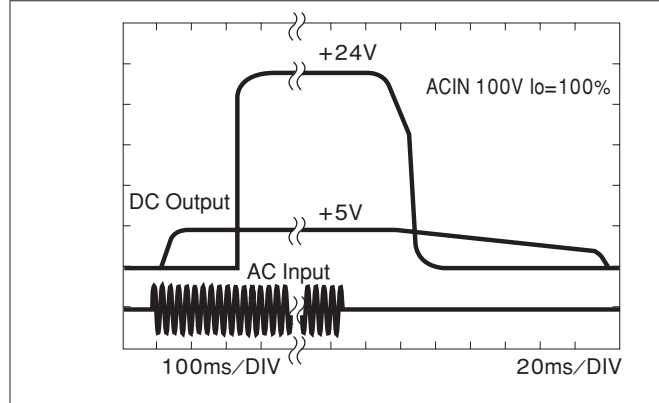

EFFICIENCY (LEB225F-0524)

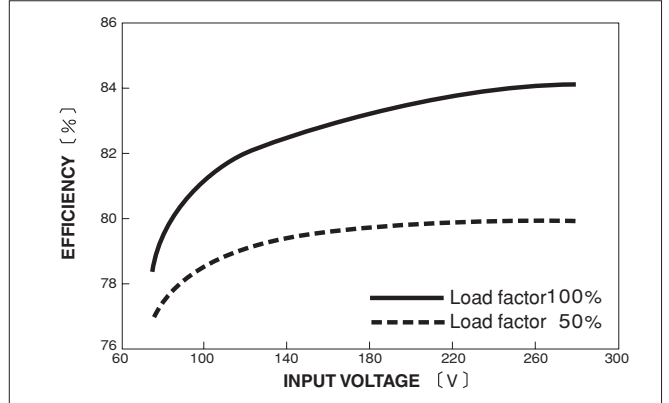

INPUT HARMONIC CURRENT (LEB225F-0524)

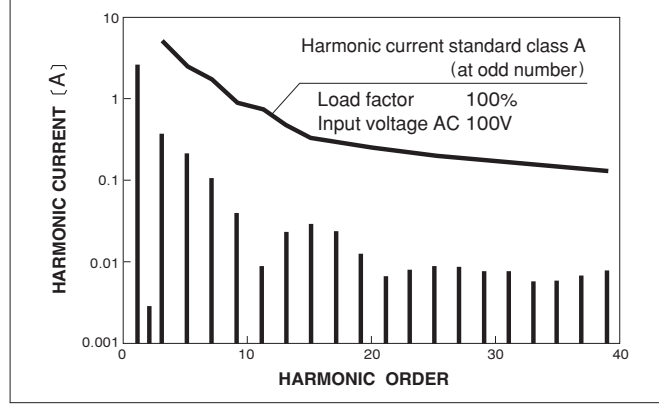

INPUT HARMONIC CURRENT (LEB225F-0524)

