

COSEL|科索 R100U-12 **PDF**

COSEL

深圳创唯电子有限公司

<http://www.cosef.net>

R10A

R 10A -5 -□

① ② ③ ④

c  us
RoHS

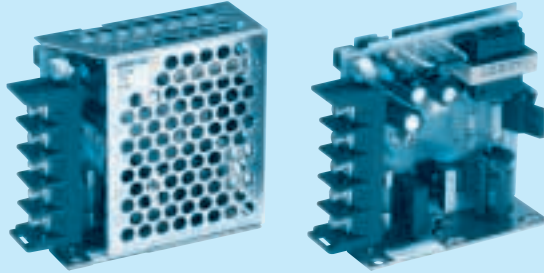

- ① Series name
- ② Output wattage
- ③ Output voltage
- ④ Optional *2
- G :Low leakage current
- J :Connector type
- N :with Cover

MODEL	R10A-3	R10A-5	R10A-12	R10A-15	R10A-24
MAX OUTPUT WATTAGE[W]	6	10	10.8	10.5	12
DC OUTPUT	3V 2.0A	5V 2.0A	12V 0.9A	15V 0.7A	24V 0.5A

SPECIFICATIONS

	MODEL	R10A-3	R10A-5	R10A-12	R10A-15	R10A-24	
INPUT	VOLTAGE[V]	AC85 - 132 1 φ or DC110 - 170					
	CURRENT[A]	ACIN 100V	0.24typ (Io=100%)				
	FREQUENCY[Hz]	47 - 440 or DC					
	EFFICIENCY[%]		64typ	70typ	75typ	76typ	78typ
	INRUSH CURRENT[A]	ACIN 100V	20typ (Io=100%) (At cold start)				
	LEAKAGE CURRENT[ma]	0.5max (According to UL, CSA and DEN-AN)					
OUTPUT	VOLTAGE[V]	3	5	12	15	24	
	CURRENT[A]	2.0	2.0	0.9	0.7	0.5	
	LINE REGULATION[mV]	20max	20max	48max	60max	96max	
	LOAD REGULATION[mV]	40max	40max	100max	120max	150max	
	RIPPLE[mVp-p]	0 to +50°C	80max	80max	120max	120max	120max
		-10 - 0°C	140max	140max	160max	160max	160max
	RIPPLE NOISE[mVp-p]	0 to +50°C	120max	120max	150max	150max	150max
		-10 - 0°C	160max	160max	180max	180max	180max
	TEMPERATURE REGULATION[mV]	0 to +50°C	50max	50max	120max	150max	240max
		-10 to +50°C	60max	60max	150max	180max	290max
DRIFT[mV]	*1	20max	20max	48max	60max	96max	
START-UP TIME[ms]	100max (ACIN 85V, Io=100%)						
HOLD-UP TIME[ms]	10typ (ACIN 85V, Io=100%, 0 to +50°C) 20typ (ACIN 100V, Io=100%, 0 to +50°C)						
OUTPUT VOLTAGE ADJUSTMENT RANGE[V]	2.85 - 3.6	4.5 - 5.5	10.8 - 13.2	13.5 - 16.5	21.6 - 26.4		
PROTECTION CIRCUIT AND OTHERS	OVERCURRENT PROTECTION	Works over 105% of rating and recovers automatically (ACIN 100V)					
	OVERVOLTAGE PROTECTION	4.00V min	Works over 115% of rating (By zener diode clamping)				
	OPERATING INDICATION	LED (Green)					
	REMOTE SENSING	Not provided					
	REMOTE ON/OFF	Not provided					
ISOLATION	INPUT-OUTPUT	AC2,000V 1minute, Cutoff current = 10mA max, DC500V 50MΩ min (At Room Temperature)					
	INPUT-FG, COVER	AC2,000V 1minute, Cutoff current = 10mA max, DC500V 50MΩ min (At Room Temperature)					
	OUTPUT-FG, COVER	AC500V 1minute, Cutoff current = 100mA max, DC500V 50MΩ min (At Room Temperature)					
ENVIRONMENT	OPERATING TEMP.,HUMID.AND ALTITUDE	-10 to +60°C, 20 - 90%RH (Non condensing) (Refer to DERATING CURVE), 3,000m (10,000feet) max					
	STORAGE TEMP.,HUMID.AND ALTITUDE	-20 to +75°C, 20 - 90%RH (Non condensing), 9,000m (30,000feet) max					
	VIBRATION	10 - 55Hz, 19.6m/s ² (2G), 3minutes period, 60minutes each along X, Y and Z axis					
	IMPACT	196.1m/s ² (20G), 11ms, once each X, Y and Z axis					
SAFETY AND NOISE REGULATIONS	AGENCY APPROVALS	UL60950-1, C-UL Complies with DEN-AN					
	CONDUCTED NOISE	Complies with FCC-B, VCCI-B					
OTHERS	CASE SIZE/WEIGHT	26 × 68 × 68mm (W × H × D) /150g max (without cover)					
	COOLING METHOD	Convection					

*1 Drift is the change in DC output for an eight hour period after a half-hour warm-up at 25°C, with the input voltage held constant at the rated input/output.
 *2 Please contact us about safety approvals for the model with option.
 * Avoid prolonged use under over-load.
 * Series/Parallel operation with other model is not possible.
 * Derating is required when operated with case cover.

External view

R

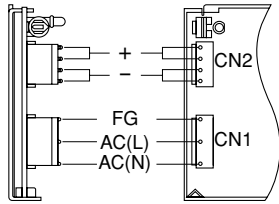

I/O Connector	Mating Connector
CN1	B3P5-VH VHR-5N
CN2	B4P-VH VHR-4N

(Mfr : J.S.T.)

Terminal
Chain: SVH-21-P1.1
Loose: BVH-21-P1.1

(Mfr : J.S.T.)

Connector type

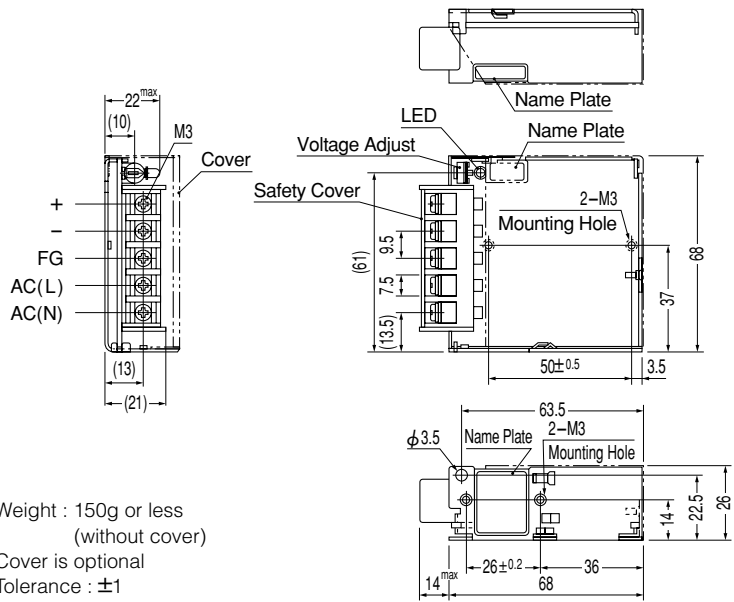

- ※Weight : 150g or less (without cover)
- ※Cover is optional
- ※Tolerance : ±1
- ※Dimensions in mm.

Barrier strip type

Mounting torque: 0.6N·m (6.3kgf·cm) max

Performance data

■ STATIC CHARACTERISTICS (R10A-5)

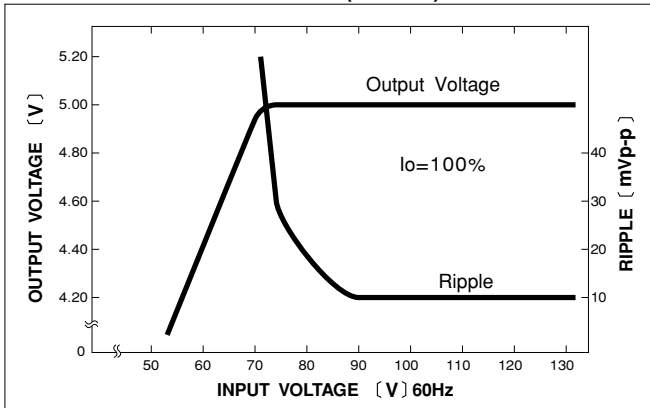

■ RISE TIME & FALL TIME (R10A-5)

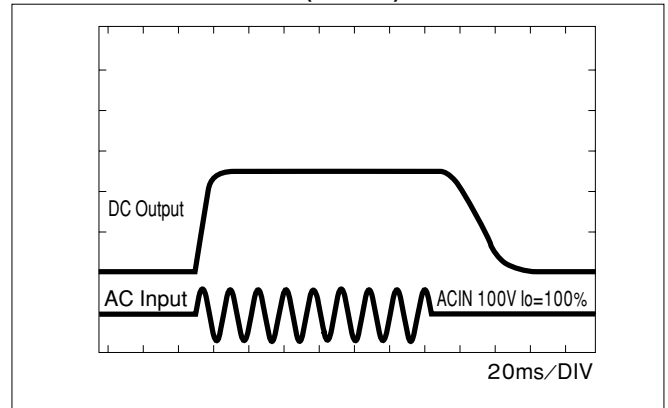

■ OVERCURRENT CHARACTERISTICS (R10A-5)

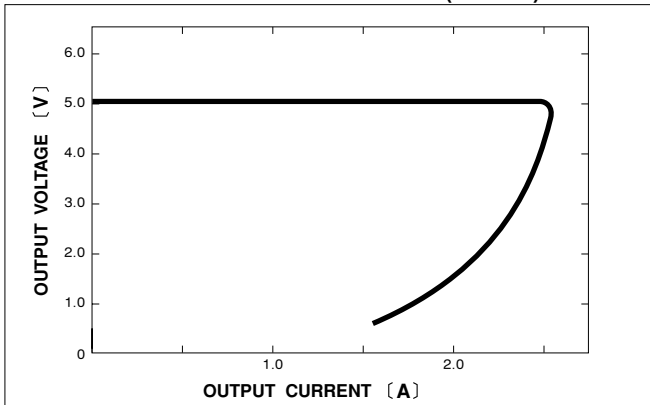

■ DERATING CURVE

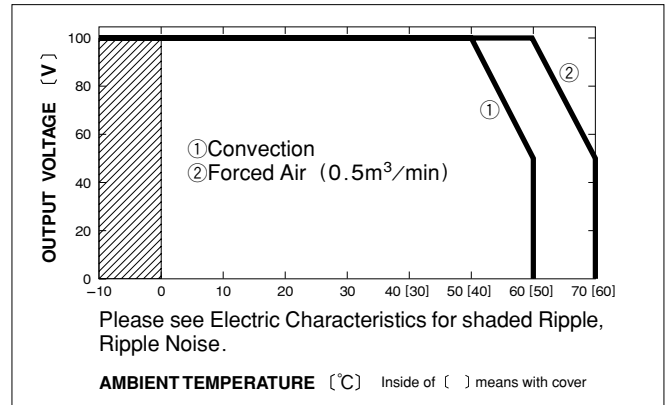

R15A

R 15A -5 -□

① ② ③ ④

c  us
RoHS

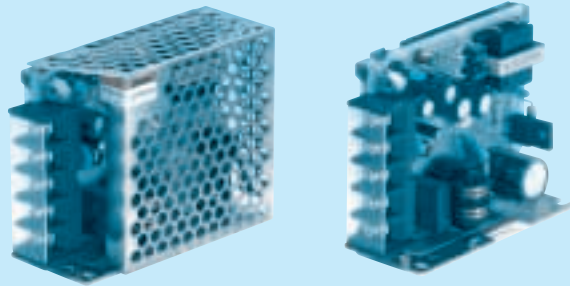

- ① Series name
- ② Output wattage
- ③ Output voltage
- ④ Optional *2
- C :with Coating
- G :Low leakage current
- J :Connector type
- N :with Cover

MODEL	R15A-3	R15A-5	R15A-9	R15A-12	R15A-15	R15A-18	R15A-24
MAX OUTPUT WATTAGE[W]	9	15	15.3	15.6	15	15.3	16.8
DC OUTPUT	3V 3.0A	5V 3A	9V 1.7A	12V 1.3A	15V 1.0A	18V 0.85A	24V 0.7A

SPECIFICATIONS

	MODEL	R15A-3	R15A-5	R15A-9	R15A-12	R15A-15	R15A-18	R15A-24	
INPUT	VOLTAGE[V]	AC85 - 132 1 φ or DC110 - 170							
	CURRENT[A]	ACIN 100V	0.37typ (Io=100%)						
	FREQUENCY[Hz]	47 - 440 or DC							
	EFFICIENCY[%]		68typ	72typ	73typ	75typ	75typ	76typ	78typ
	INRUSH CURRENT[A]	ACIN 100V	20typ (Io=100%) (At cold start)						
	LEAKAGE CURRENT[ma]		0.5max (According to UL, CSA and DEN-AN)						
OUTPUT	VOLTAGE[V]	3	5	9	12	15	18	24	
	CURRENT[A]	3.0	3.0	1.7	1.3	1.0	0.85	0.7	
	LINE REGULATION[mV]	20max	20max	36max	48max	60max	72max	96max	
	LOAD REGULATION[mV]	40max	40max	100max	100max	120max	120max	150max	
	RIPPLE[mVp-p]	0 to +50°C	80max	80max	120max	120max	120max	120max	120max
		-10 - 0°C	140max	140max	160max	160max	160max	160max	160max
	RIPPLE NOISE[mVp-p]	0 to +50°C	120max	120max	150max	150max	150max	150max	150max
		-10 - 0°C	160max	160max	180max	180max	180max	180max	180max
	TEMPERATURE REGULATION[mV]	0 to +50°C	50max	50max	90max	120max	150max	180max	240max
		-10 to +50°C	60max	60max	120max	150max	180max	200max	290max
DRIFT[mV]	*1	20max	20max	36max	48max	60max	72max	96max	
START-UP TIME[ms]		100max (ACIN 85V, Io=100%)							
HOLD-UP TIME[ms]		10typ (ACIN 85V, Io=100%, 0 to +50°C) 20typ (ACIN 100V, Io=100%, 0 to +50°C)							
OUTPUT VOLTAGE ADJUSTMENT RANGE[V]		2.85 - 3.6	4.5 - 5.5	8.1 - 9.9	10.8 - 13.2	13.5 - 16.5	16.2 - 19.8	21.6 - 26.4	
PROTECTION CIRCUIT AND OTHERS	OVERCURRENT PROTECTION	Works over 105% of rating and recovers automatically (ACIN 100V)							
	OVERVOLTAGE PROTECTION	4.00V min	Works over 115% of rating (By zener diode clamping)						
	OPERATING INDICATION	LED (Green)							
	REMOTE SENSING	Not provided							
	REMOTE ON/OFF	Not provided							
ISOLATION	INPUT-OUTPUT	AC2,000V 1minute, Cutoff current = 10mA max, DC500V 50MΩ min (At Room Temperature)							
	INPUT-FG, COVER	AC2,000V 1minute, Cutoff current = 10mA max, DC500V 50MΩ min (At Room Temperature)							
	OUTPUT-FG, COVER	AC500V 1minute, Cutoff current = 100mA max, DC500V 50MΩ min (At Room Temperature)							
ENVIRONMENT	OPERATING TEMP.,HUMID.AND ALTITUDE	-10 to +60°C, 20 - 90%RH (Non condensing) (Refer to DERATING CURVE), 3,000m (10,000feet) max							
	STORAGE TEMP.,HUMID.AND ALTITUDE	-20 to +75°C, 20 - 90%RH (Non condensing), 9,000m (30,000feet) max							
	VIBRATION	10 - 55Hz, 19.6m/s ² (2G), 3minutes period, 60minutes each along X, Y and Z axis							
	IMPACT	196.1m/s ² (20G), 11ms, once each X, Y and Z axis							
SAFETY AND NOISE REGULATIONS	AGENCY APPROVALS	UL60950-1, C-UL Complies with DEN-AN							
	CONDUCTED NOISE	Complies with FCC-B, VCCI-B							
OTHERS	CASE SIZE/WEIGHT	30 × 69 × 84mm (W × H × D) / 200g max (without cover)							
	COOLING METHOD	Convection							

*1 Drift is the change in DC output for an eight hour period after a half-hour warm-up at 25°C, with the input voltage held constant at the rated input/output.
 *2 Please contact us about safety approvals for the model with option.
 * Avoid prolonged use under over-load.
 * Series/Parallel operation with other model is not possible.
 * Derating is required when operated with case cover.

External view

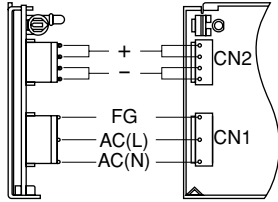

I/O Connector	Mating Housing
CN1	B3P5-VH VHR-5N
CN2	B4P-VH VHR-4N

(Mfr : J.S.T.)

Terminal
Chain: SVH-21-P1.1
Loose: BVH-21-P1.1

(Mfr : J.S.T.)

Connector type

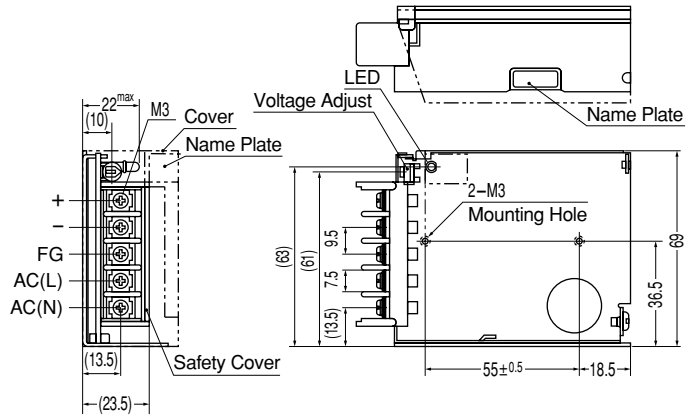

- ※Weight : 200g or less (without cover)
- ※Cover is optional
- ※Tolerance : ± 1
- ※Dimensions in mm.

Barrier strip type

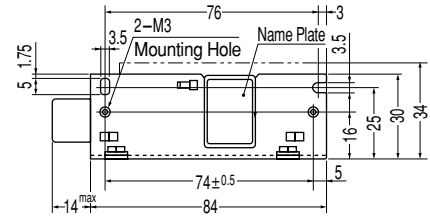

Mounting torque: 0.6N·m (6.3kgf·cm) max

Performance data

■ STATIC CHARACTERISTICS (R15A-5)

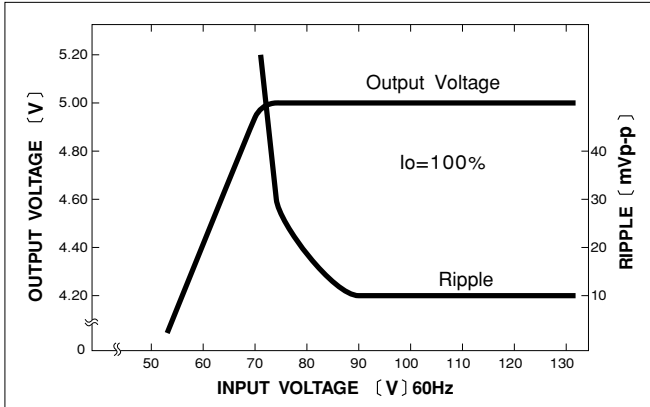

■ RISE TIME & FALL TIME (R15A-5)

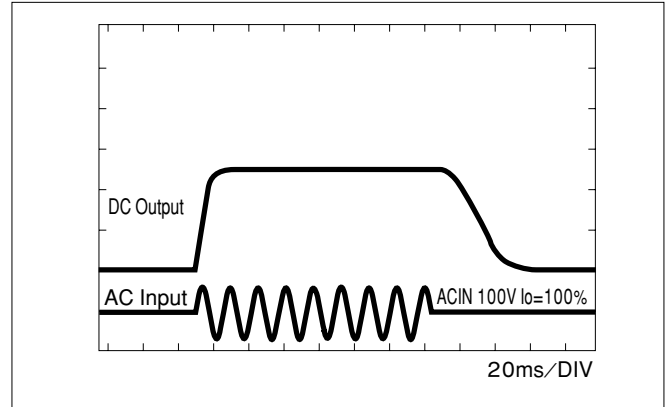

■ OVERCURRENT CHARACTERISTICS (R15A-5)

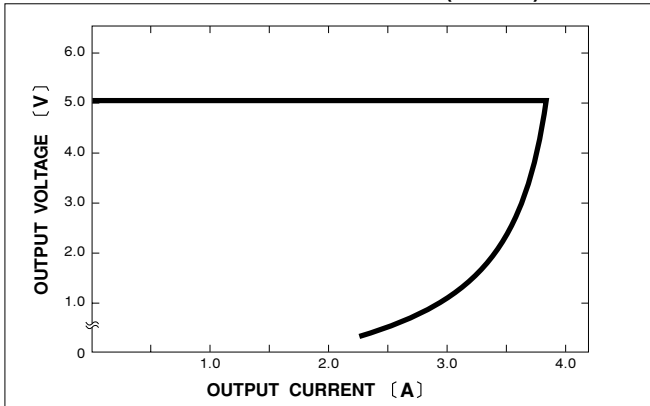

■ INRUSH CURRENT (R15A-5)

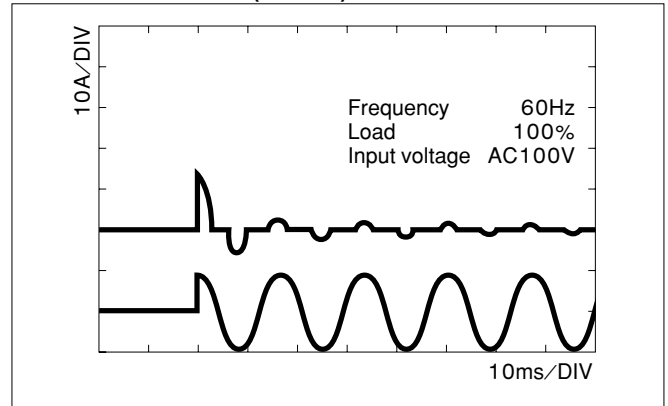

R25A

R 25A -5 -□

① ② ③ ④

c  us
RoHS

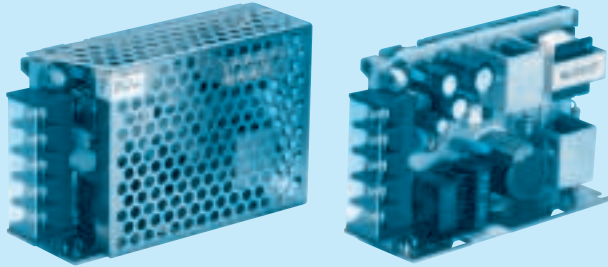

- ① Series name
- ② Output wattage
- ③ Output voltage
- ④ Optional *2
- C :with Coating
- G :Low leakage current
- J :Connector type
- N :with Cover

MODEL	R25A-3	R25A-5	R25A-9	R25A-12	R25A-15	R25A-18	R25A-24
MAX OUTPUT WATTAGE[W]	15	25	25.2	25.2	25.5	25.2	26.4
DC OUTPUT	3V 5.0A	5V 5A	9V 2.8A	12V 2.1A	15V 1.7A	18V 1.4A	24V 1.1A

SPECIFICATIONS

	MODEL	R25A-3	R25A-5	R25A-9	R25A-12	R25A-15	R25A-18	R25A-24	
INPUT	VOLTAGE[V]	AC85 - 132 1 φ or DC110 - 170							
	CURRENT[A]	ACIN 100V	0.58typ (Io=100%)						
	FREQUENCY[Hz]	47 - 440 or DC							
	EFFICIENCY[%]		69typ	73typ	75typ	76typ	76typ	77typ	79typ
	INRUSH CURRENT[A]	ACIN 100V	20typ (Io=100%) (At cold start)						
	LEAKAGE CURRENT[ma]	0.5max (According to UL, CSA and DEN-AN)							
OUTPUT	VOLTAGE[V]	3	5	9	12	15	18	24	
	CURRENT[A]	5.0	5.0	2.8	2.1	1.7	1.4	1.1	
	LINE REGULATION[mV]	20max	20max	36max	48max	60max	72max	96max	
	LOAD REGULATION[mV]	40max	40max	100max	100max	120max	120max	150max	
	RIPPLE[mVp-p]	0 to +50°C	80max	80max	120max	120max	120max	120max	120max
		-10 - 0°C	140max	140max	160max	160max	160max	160max	160max
	RIPPLE NOISE[mVp-p]	0 to +50°C	120max	120max	150max	150max	150max	150max	150max
		-10 - 0°C	160max	160max	180max	180max	180max	180max	180max
	TEMPERATURE REGULATION[mV]	0 to +50°C	50max	50max	90max	120max	150max	180max	240max
		-10 to +50°C	60max	60max	120max	150max	180max	200max	290max
DRIFT[mV]	*1	20max	20max	36max	48max	60max	72max	96max	
START-UP TIME[ms]	200max (ACIN 85V, Io=100%)								
HOLD-UP TIME[ms]	10typ (ACIN 85V, Io=100%, 0 to +50°C) 20typ (ACIN 100V, Io=100%, 0 to +50°C)								
OUTPUT VOLTAGE ADJUSTMENT RANGE[V]	2.85 - 3.6	4.5 - 5.5	8.1 - 9.9	10.8 - 13.2	13.5 - 16.5	16.2 - 19.8	21.6 - 26.4		
PROTECTION CIRCUIT AND OTHERS	OVERCURRENT PROTECTION	Works over 105% of rating and recovers automatically (ACIN 100V)							
	OVERVOLTAGE PROTECTION	4.00 - 5.25V	Works at 115 - 140% of rating						
	OPERATING INDICATION	LED (Green)							
	REMOTE SENSING	Not provided							
	REMOTE ON/OFF	Not provided							
ISOLATION	INPUT-OUTPUT	AC2,000V 1minute, Cutoff current = 10mA max, DC500V 50MΩ min (At Room Temperature)							
	INPUT-FG, COVER	AC2,000V 1minute, Cutoff current = 10mA max, DC500V 50MΩ min (At Room Temperature)							
	OUTPUT-FG, COVER	AC500V 1minute, Cutoff current = 100mA max, DC500V 50MΩ min (At Room Temperature)							
ENVIRONMENT	OPERATING TEMP.,HUMID.AND ALTITUDE	-10 to +60°C, 20 - 90%RH (Non condensing) (Refer to DERATING CURVE), 3,000m (10,000feet) max							
	STORAGE TEMP.,HUMID.AND ALTITUDE	-20 to +75°C, 20 - 90%RH (Non condensing), 9,000m (30,000feet) max							
	VIBRATION	10 - 55Hz, 19.6m/s ² (2G), 3minutes period, 60minutes each along X, Y and Z axis							
	IMPACT	196.1m/s ² (20G), 11ms, once each X, Y and Z axis							
SAFETY AND NOISE REGULATIONS	AGENCY APPROVALS	UL60950-1, C-UL Complies with DEN-AN							
	CONDUCTED NOISE	Complies with FCC-B, VCCI-B							
OTHERS	CASE SIZE/WEIGHT	31 × 69 × 104mm (W × H × D) / 250g max (without cover)							
	COOLING METHOD	Convection							

*1 Drift is the change in DC output for an eight hour period after a half-hour warm-up at 25°C, with the input voltage held constant at the rated input/output.
 *2 Please contact us about safety approvals for the model with option.
 * Avoid prolonged use under over-load.
 * Series/Parallel operation with other model is not possible.
 * Derating is required when operated with case cover.

External view

R

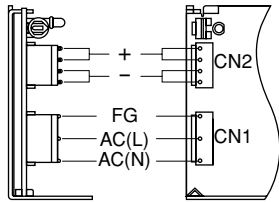

I/O Connector	Mating Housing
CN1	B3P5-VH VHR-5N
CN2	B4P-VH VHR-4N

(Mfr : J.S.T.)

Terminal
Chain: SVH-21-P1.1
Loose: BVH-21-P1.1

(Mfr : J.S.T.)

Connector type

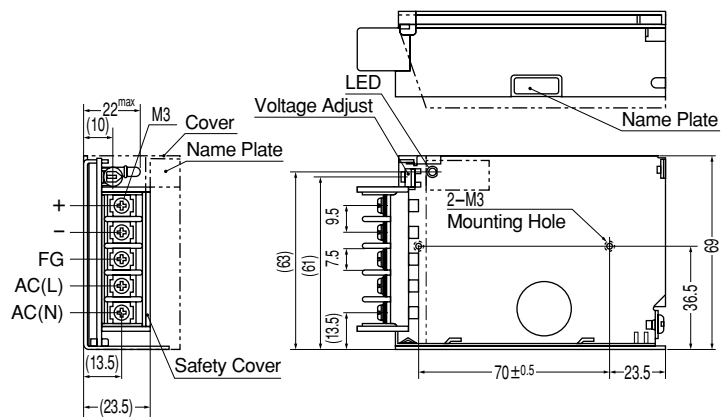

- ※Weight : 250g or less (without cover)
- ※Cover is optional
- ※Tolerance : ±1
- ※Dimensions in mm.

Barrier strip type

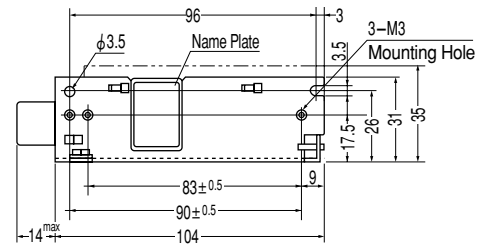

Mounting torque: 0.6N•m (6.3kgf•cm) max

Performance data

■ STATIC CHARACTERISTICS (R25A-5)

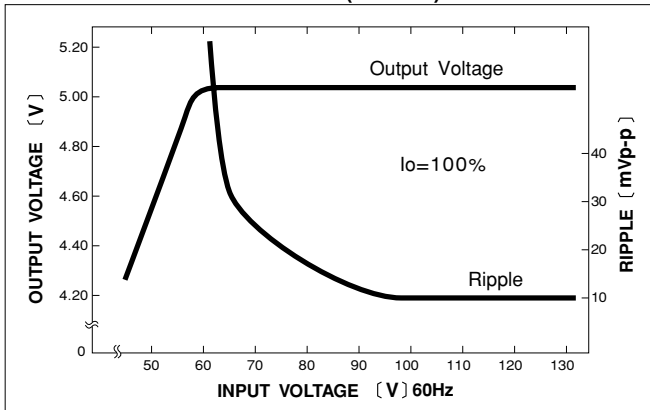

■ RISE TIME & FALL TIME (R25A-5)

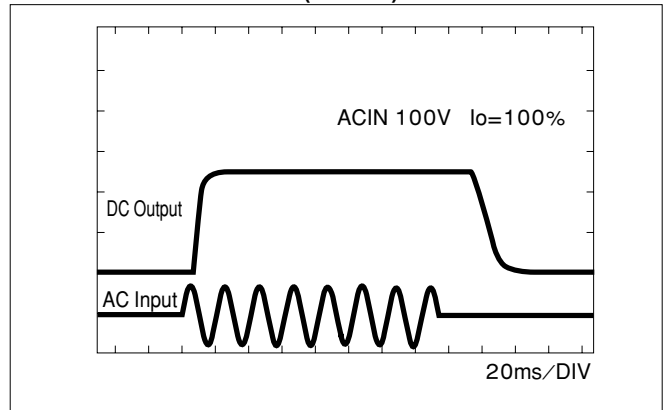

■ OVERCURRENT CHARACTERISTICS (R25A-5)

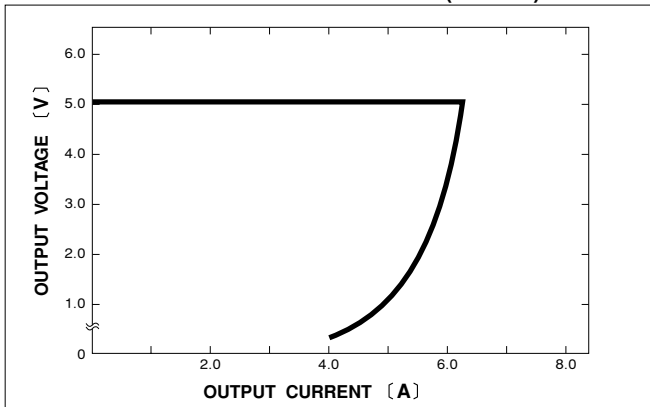

■ INRUSH CURRENT (R25A-5)

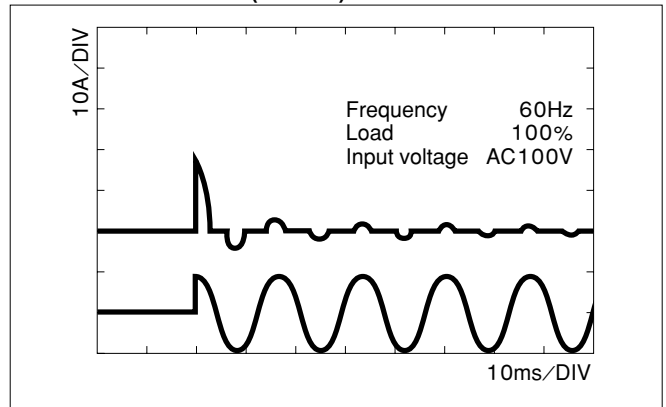

R50A

R 50A -5 -□

① ② ③ ④

c  us
RoHS

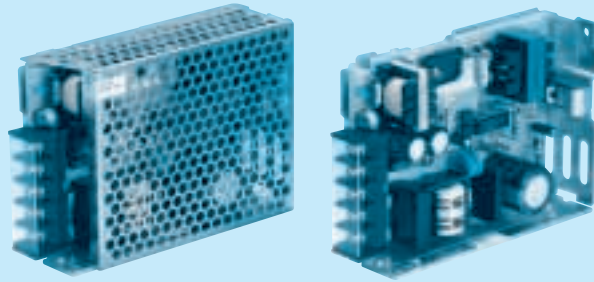

- ① Series name
- ② Output wattage
- ③ Output voltage
- ④ Optional *2
- C :with Coating
- G :Low leakage current
- J :Connector type
- N :with Cover

MODEL	R50A-3	R50A-5	R50A-9	R50A-12	R50A-15	R50A-18	R50A-24
MAX OUTPUT WATTAGE[W]	30	50	50.4	50.4	51	50.4	52.8
DC OUTPUT	3V 10A	5V 10A	9V 5.6A	12V 4.2A	15V 3.4A	18V 2.8A	24V 2.2A

SPECIFICATIONS

	MODEL	R50A-3	R50A-5	R50A-9	R50A-12	R50A-15	R50A-18	R50A-24	
INPUT	VOLTAGE[V]	AC85 - 132 1 φ or DC110 - 170							
	CURRENT[A]	ACIN 100V	1.1typ (Io=100%)						
	FREQUENCY[Hz]	47 - 440 or DC							
	EFFICIENCY[%]		74typ	78typ	79typ	80typ	81typ	82typ	83typ
	INRUSH CURRENT[A]	ACIN 100V	30typ (Io=100%) (At cold start)						
	LEAKAGE CURRENT[ma]	0.5max (According to UL, CSA and DEN-AN)							
OUTPUT	VOLTAGE[V]	3	5	9	12	15	18	24	
	CURRENT[A]	10	10	5.6	4.2	3.4	2.8	2.2	
	LINE REGULATION[mV]	20max	20max	36max	48max	60max	72max	96max	
	LOAD REGULATION[mV]	40max	40max	100max	100max	120max	120max	150max	
	RIPPLE[mVp-p]	0 to +50°C	80max	80max	120max	120max	120max	120max	120max
		-10 - 0°C	140max	140max	160max	160max	160max	160max	160max
	RIPPLE NOISE[mVp-p]	0 to +50°C	120max	120max	150max	150max	150max	150max	150max
		-10 - 0°C	160max	160max	180max	180max	180max	180max	180max
	TEMPERATURE REGULATION[mV]	0 to +50°C	50max	50max	90max	120max	150max	180max	240max
		-10 to +50°C	60max	60max	120max	150max	180max	200max	290max
DRIFT[mV]	*1	20max	20max	36max	48max	60max	72max	96max	
START-UP TIME[ms]	200max (ACIN 85V, Io=100%)								
HOLD-UP TIME[ms]	10typ (ACIN 85V, Io=100%, 0 to +50°C) 20typ (ACIN 100V, Io=100%, 0 to +50°C)								
OUTPUT VOLTAGE ADJUSTMENT RANGE[V]	2.85 - 3.6	4.5 - 5.5	8.1 - 9.9	10.8 - 13.2	13.5 - 16.5	16.2 - 19.8	21.6 - 26.4		
PROTECTION CIRCUIT AND OTHERS	OVERCURRENT PROTECTION	Works over 105% of rating and recovers automatically (ACIN 100V)							
	OVERVOLTAGE PROTECTION	4.00 - 5.25V	Works at 115 - 140% of rating						
	OPERATING INDICATION	LED (Green)							
	REMOTE SENSING	Not provided							
	REMOTE ON/OFF	Not provided							
ISOLATION	INPUT-OUTPUT	AC2,000V 1minute, Cutoff current = 10mA max, DC500V 50MΩ min (At Room Temperature)							
	INPUT-FG, COVER	AC2,000V 1minute, Cutoff current = 10mA max, DC500V 50MΩ min (At Room Temperature)							
	OUTPUT-FG, COVER	AC500V 1minute, Cutoff current = 100mA max, DC500V 50MΩ min (At Room Temperature)							
ENVIRONMENT	OPERATING TEMP.,HUMID.AND ALTITUDE	-10 to +60°C, 20 - 90%RH (Non condensing) (Refer to DERATING CURVE), 3,000m (10,000feet) max							
	STORAGE TEMP.,HUMID.AND ALTITUDE	-20 to +75°C, 20 - 90%RH (Non condensing), 9,000m (30,000feet) max							
	VIBRATION	10 - 55Hz, 19.6m/s ² (2G), 3minutes period, 60minutes each along X, Y and Z axis							
	IMPACT	196.1m/s ² (20G), 11ms, once each X, Y and Z axis							
SAFETY AND NOISE REGULATIONS	AGENCY APPROVALS	UL60950-1, C-UL Complies with DEN-AN							
	CONDUCTED NOISE	Complies with FCC-B, VCCI-B							
OTHERS	CASE SIZE/WEIGHT	33 × 85 × 119mm (W × H × D) / 300g max (without cover)							
	COOLING METHOD	Convection							

*1 Drift is the change in DC output for an eight hour period after a half-hour warm-up at 25°C, with the input voltage held constant at the rated input/output.
 *2 Please contact us about safety approvals for the model with option.
 * Avoid prolonged use under over-load.
 * Parallel operation is not possible.
 * Derating is required when operated with case cover.

External view

R

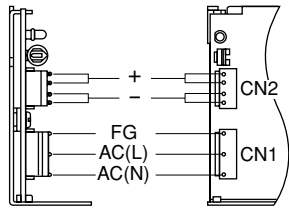

I/O Connector	Mating Housing
CN1	B3P5-VH VHR-5N
CN2	B4P-VH VHR-4N

(Mfr : J.S.T.)

Terminal
Chain: SVH-21-P1.1
Loose: BVH-21-P1.1

(Mfr : J.S.T.)

Connector type

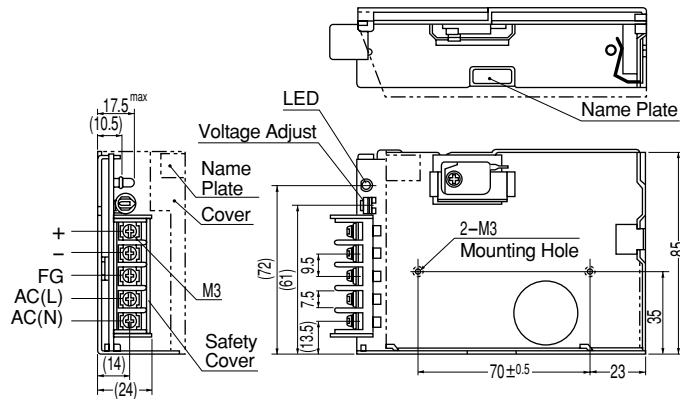

- ※Weight : 300g or less (without cover)
- ※Cover is optional
- ※Tolerance : ±1
- ※Dimensions in mm.

Barrier strip type

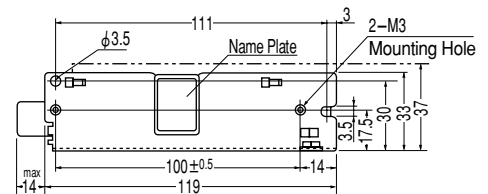

Mounting torque: 0.49N·m (5.0kgf·cm) max

Performance data

■ STATIC CHARACTERISTICS (R50A-5)

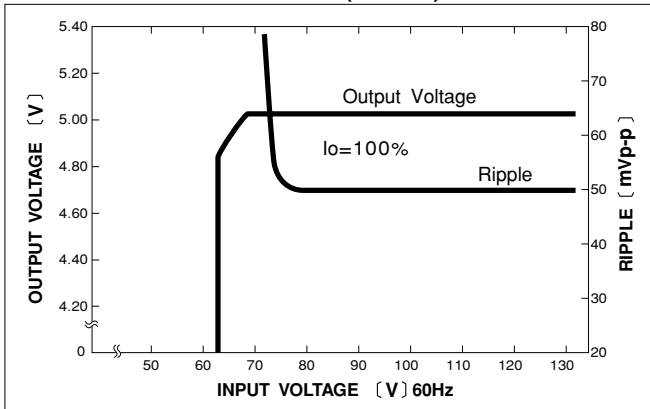

■ RISE TIME & FALL TIME (R50A-5)

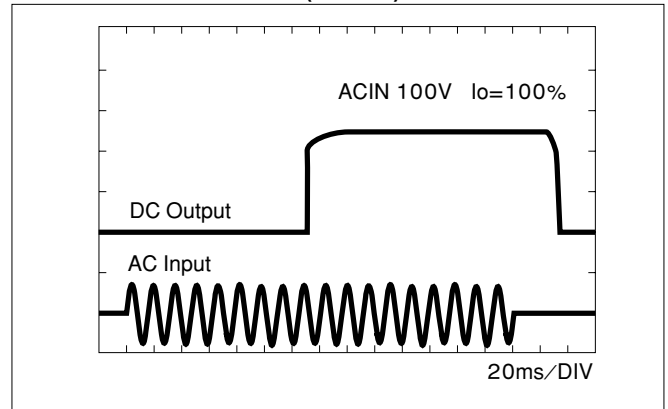

■ OVERCURRENT CHARACTERISTICS (R50A-5)

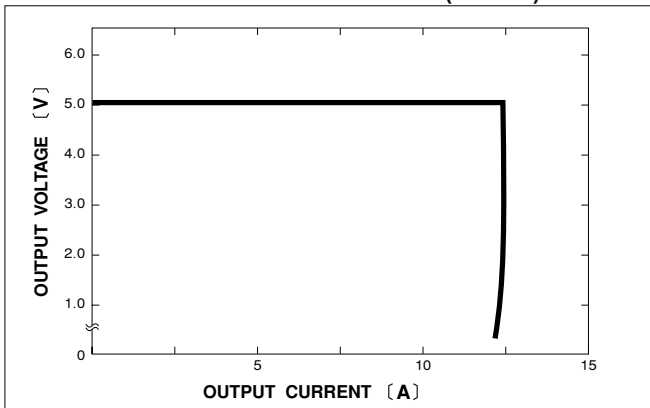

■ INRUSH CURRENT (R50A-5)

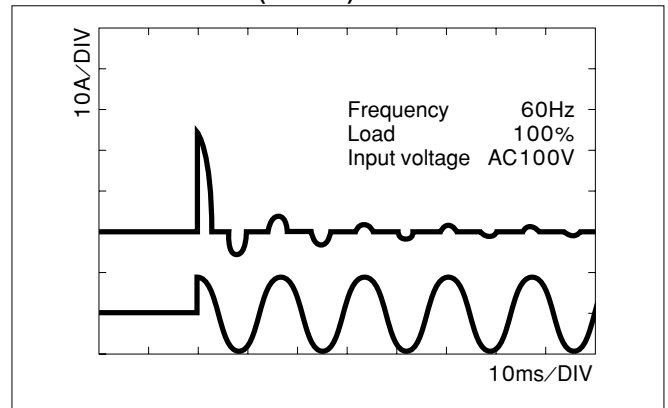

R100U

R 100 U -5 -□

① ② ③ ④ ⑤

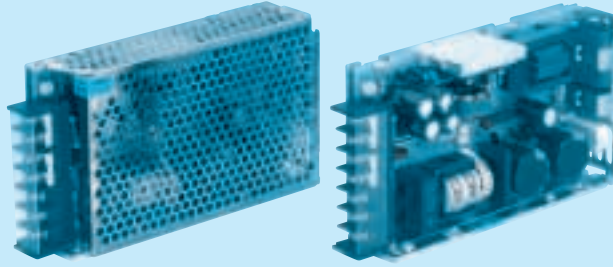

- ① Series name
- ② Output wattage
- ③ UL recognized, TÜV approved, CSA certified
- ④ Output voltage
- ⑤ Optional *2
C :with Coating
G :Low leakage current
N :with Cover

MODEL	R100U-3	R100U-5	R100U-9	R100U-12	R100U-15	R100U-18	R100U-24
MAX OUTPUT WATTAGE[W]	60	100	103.5	102	105	100.8	108
DC OUTPUT	3V 20A	5V 20A	9V 11.5A	12V 8.5A	15V 7A	18V 5.6A	24V 4.5A

SPECIFICATIONS

	MODEL	R100U-3	R100U-5	R100U-9	R100U-12	R100U-15	R100U-18	R100U-24	
INPUT	VOLTAGE[V]	AC85 - 132 1 φ or DC110 - 170							
	CURRENT[A]	ACIN 100V	2.8typ (Io=100%)						
	FREQUENCY[Hz]	47 - 440 or DC							
	EFFICIENCY[%]		75typ	79typ	80typ	82typ	83typ	84typ	85typ
	INRUSH CURRENT[A]	ACIN 100V	15typ (Io=100%)						
	LEAKAGE CURRENT[ma]	0.5max (60Hz, According to UL, CSA and DEN-AN)							
OUTPUT	VOLTAGE[V]	3	5	9	12	15	18	24	
	CURRENT[A]	20	20	11.5	8.5	7	5.6	4.5	
	LINE REGULATION[mV]	20max	20max	36max	48max	60max	72max	96max	
	LOAD REGULATION[mV]	40max	40max	100max	100max	120max	120max	150max	
	RIPPLE[mVp-p]	0 to +50°C	80max	80max	120max	120max	120max	120max	120max
		-10 - 0°C	140max	140max	160max	160max	160max	160max	160max
	RIPPLE NOISE[mVp-p]	0 to +50°C	120max	120max	150max	150max	150max	150max	150max
		-10 - 0°C	160max	160max	180max	180max	180max	180max	180max
	TEMPERATURE REGULATION[mV]	0 to +50°C	50max	50max	90max	120max	150max	180max	240max
		-10 to +50°C	60max	60max	120max	150max	180max	200max	290max
DRIFT[mV]	*1	20max	20max	36max	48max	60max	72max	96max	
START-UP TIME[ms]	200max (ACIN 85V, Io=100%)								
HOLD-UP TIME[ms]	20typ (ACIN 100V, Io=100%, 0 to +50°C) 10typ (ACIN 85V, Io=100%, 0 to +50°C)								
OUTPUT VOLTAGE ADJUSTMENT RANGE[V]		2.85 - 3.6	4.5 - 5.5	8.1 - 9.9	10.8 - 13.2	13.5 - 16.5	16.2 - 19.8	21.6 - 26.4	
PROTECTION CIRCUIT AND OTHERS	OVERCURRENT PROTECTION	Works over 105% of rating and recovers automatically							
	OVERVOLTAGE PROTECTION	4.00 - 5.25V	Works at 115 - 140% of rating						
	OPERATING INDICATION	LED (Green)							
	REMOTE SENSING	Provided							
	REMOTE ON/OFF	Not provided							
ISOLATION	INPUT-OUTPUT	AC2,000V 1minute, Cutoff current = 10mA max, DC500V 50MΩ min (At Room Temperature)							
	INPUT-FG, COVER	AC2,000V 1minute, Cutoff current = 10mA max, DC500V 50MΩ min (At Room Temperature)							
	OUTPUT-FG, COVER	AC500V 1minute, Cutoff current = 100mA max, DC500V 50MΩ min (At Room Temperature)							
ENVIRONMENT	OPERATING TEMP., HUMID. AND ALTITUDE	-10 to +60°C, 20 - 90%RH (Non condensing) (Refer to DERATING CURVE), 3,000m (10,000feet) max							
	STORAGE TEMP., HUMID. AND ALTITUDE	-20 to +75°C, 20 - 90%RH (Non condensing), 9,000m (30,000feet) max							
	VIBRATION	10 - 55Hz, 19.6m/s ² (2G), 3minutes period, 60minutes each along X, Y and Z axis							
	IMPACT	196.1m/s ² (20G), 11ms, once each X, Y and Z axis							
SAFETY AND NOISE REGULATIONS	AGENCY APPROVALS	UL60950-1, CSA C22.2 No.60950-1, EN60950-1 Complies with DEN-AN and IEC60950-1							
	CONDUCTED NOISE	Complies with FCC-B, VCCI-B							
OTHERS	CASE SIZE/WEIGHT	34.5 × 93 × 160mm (W × H × D) / 600gmax (without cover)							
	COOLING METHOD	Convection							

*1 Drift is the change in DC output for an eight hour period after a half-hour warm-up at 25°C, with the input voltage held constant at the rated input/output.
 *2 Please contact us about safety approvals for the model with option.
 * Avoid prolonged use under over-load.
 * Parallel operation with other model is not possible.
 * Derating is required when operated with case cover.

External view

R

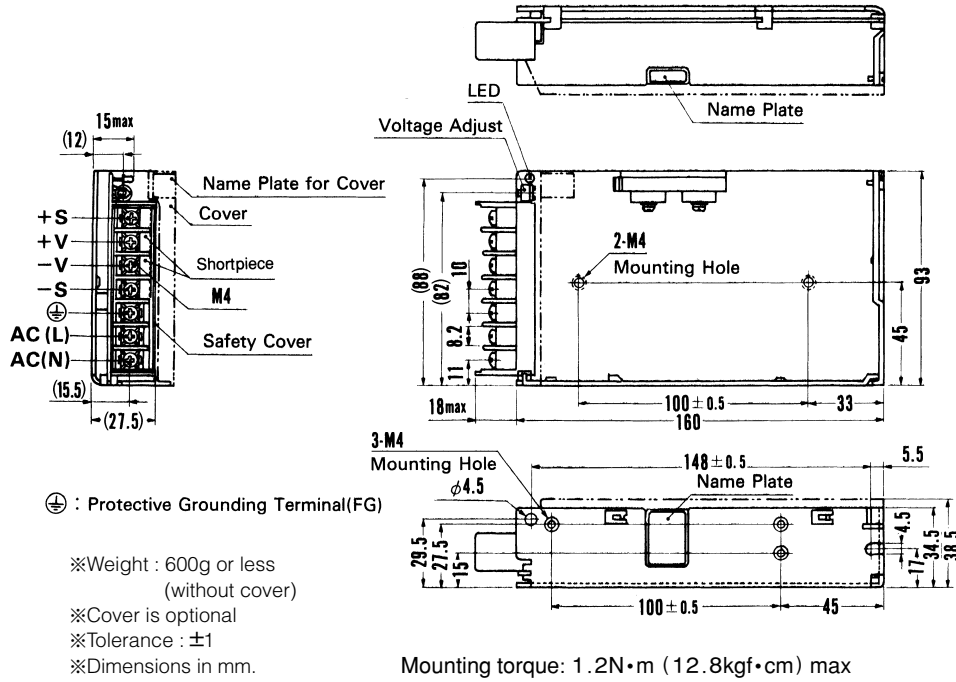

Performance data

■ STATIC CHARACTERISTICS (R100U-5)

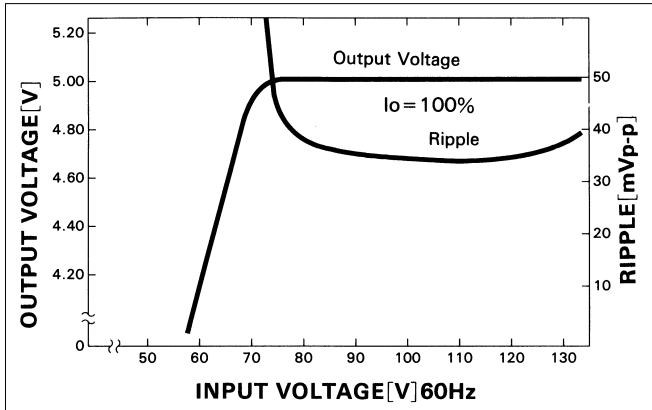

■ RISE TIME & FALL TIME (R100U-5)

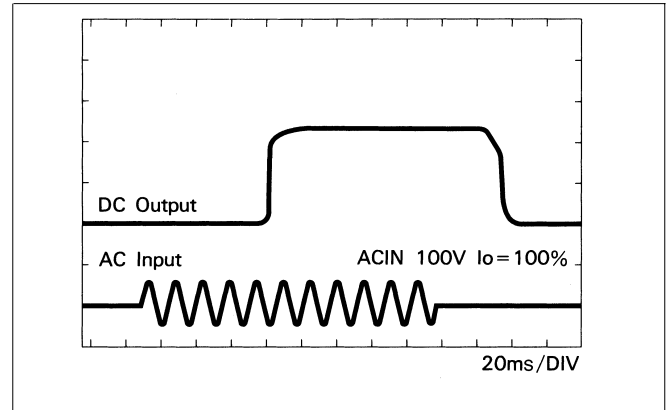

■ OVERCURRENT CHARACTERISTICS (R100U-5)

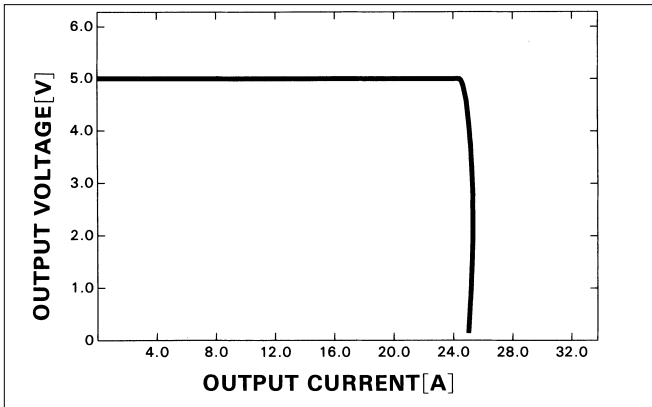

■ DERATING CURVE

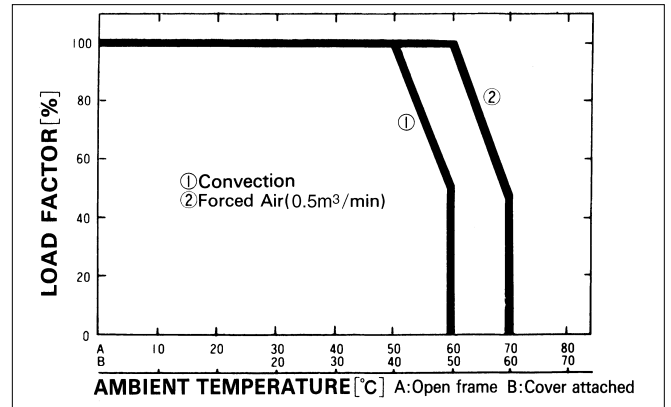

R150U

R 150 U -5 -□

① ② ③ ④ ⑤

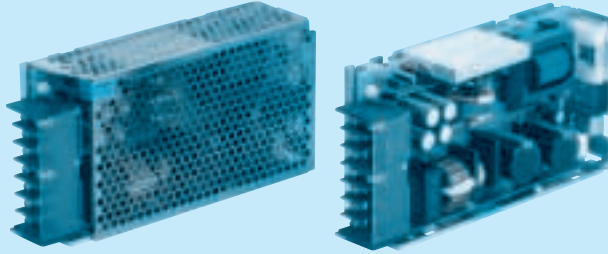

- ① Series name
- ② Output wattage
- ③ UL recognized, TÜV approved, CSA certified
- ④ Output voltage
- ⑤ Optional *2
C :with Coating
G :Low leakage current
N :with Cover

MODEL	R150U-3	R150U-5	R150U-9	R150U-12	R150U-15	R150U-18	R150U-24
MAX OUTPUT WATTAGE[W]	90	150	153	156	150	153	156
DC OUTPUT	3V 30A	5V 30A	9V 17A	12V 13A	15V 10A	18V 8.5A	24V 6.5A

SPECIFICATIONS

	MODEL	R150U-3	R150U-5	R150U-9	R150U-12	R150U-15	R150U-18	R150U-24	
INPUT	VOLTAGE[V]	AC85 - 132 1 φ or DC110 - 170							
	CURRENT[A]	ACIN 100V	4.2typ (Io=100%)						
	FREQUENCY[Hz]	47 - 440 or DC							
	EFFICIENCY[%]		74typ	78typ	79typ	80typ	82typ	83typ	84typ
	INRUSH CURRENT[A]	ACIN 100V	15typ (Io=100%)						
	LEAKAGE CURRENT[ma]	0.5max (60Hz, According to UL, CSA and DEN-AN)							
OUTPUT	VOLTAGE[V]	3	5	9	12	15	18	24	
	CURRENT[A]	30	30	17	13	10	8.5	6.5	
	LINE REGULATION[mV]	20max	20max	36max	48max	60max	72max	96max	
	LOAD REGULATION[mV]	40max	40max	100max	100max	120max	120max	150max	
	RIPPLE[mVp-p]	0 to +50°C	80max	80max	120max	120max	120max	120max	120max
		-10 - 0°C	140max	140max	160max	160max	160max	160max	160max
	RIPPLE NOISE[mVp-p]	0 to +50°C	120max	120max	150max	150max	150max	150max	150max
		-10 - 0°C	160max	160max	180max	180max	180max	180max	180max
	TEMPERATURE REGULATION[mV]	0 to +50°C	50max	50max	90max	120max	150max	180max	240max
		-10 to +50°C	60max	60max	120max	150max	180max	200max	290max
DRIFT[mV]	*1	20max	20max	36max	48max	60max	72max	96max	
START-UP TIME[ms]	200max (ACIN 85V, Io=100%)								
HOLD-UP TIME[ms]	20typ (ACIN 100V, Io=100%, 0 to +50°C) 10typ (ACIN 85V, Io=100%, 0 to +50°C)								
OUTPUT VOLTAGE ADJUSTMENT RANGE[V]		2.85 - 3.6	4.5 - 5.5	8.1 - 9.9	10.8 - 13.2	13.5 - 16.5	16.2 - 19.8	21.6 - 26.4	
PROTECTION CIRCUIT AND OTHERS	OVERCURRENT PROTECTION	Works over 105% of rating and recovers automatically							
	OVERVOLTAGE PROTECTION	4.00 - 5.25V	Works at 115 - 140% of rating						
	OPERATING INDICATION	LED (Green)							
	REMOTE SENSING	Provided							
	REMOTE ON/OFF	Not provided							
ISOLATION	INPUT-OUTPUT	AC2,000V 1minute, Cutoff current = 10mA max, DC500V 50MΩ min (At Room Temperature)							
	INPUT-FG, COVER	AC2,000V 1minute, Cutoff current = 10mA max, DC500V 50MΩ min (At Room Temperature)							
	OUTPUT-FG, COVER	AC500V 1minute, Cutoff current = 100mA max, DC500V 50MΩ min (At Room Temperature)							
ENVIRONMENT	OPERATING TEMP., HUMID. AND ALTITUDE	-10 to +60°C, 20 - 90%RH (Non condensing) (Refer to DERATING CURVE), 3,000m (10,000feet) max							
	STORAGE TEMP., HUMID. AND ALTITUDE	-20 to +75°C, 20 - 90%RH (Non condensing), 9,000m (30,000feet) max							
	VIBRATION	10 - 55Hz, 19.6m/s ² (2G), 3minutes period, 60minutes each along X, Y and Z axis							
	IMPACT	196.1m/s ² (20G), 11ms, once each X, Y and Z axis							
SAFETY AND NOISE REGULATIONS	AGENCY APPROVALS	UL60950-1, CSA C22.2 No.60950-1, EN60950-1 Complies with DEN-AN and IEC60950-1							
	CONDUCTED NOISE	Complies with FCC-B, VCCI-B							
OTHERS	CASE SIZE/WEIGHT	44.5 × 93 × 175mm (W × H × D) / 900g max (without cover)							
	COOLING METHOD	Convection							

*1 Drift is the change in DC output for an eight hour period after a half-hour warm-up at 25°C, with the input voltage held constant at the rated input/output.
 *2 Please contact us about safety approvals for the model with option.
 * Avoid prolonged use under over-load.
 * Parallel operation with other model is not possible.
 * Derating is required when operated with case cover.

External view

R

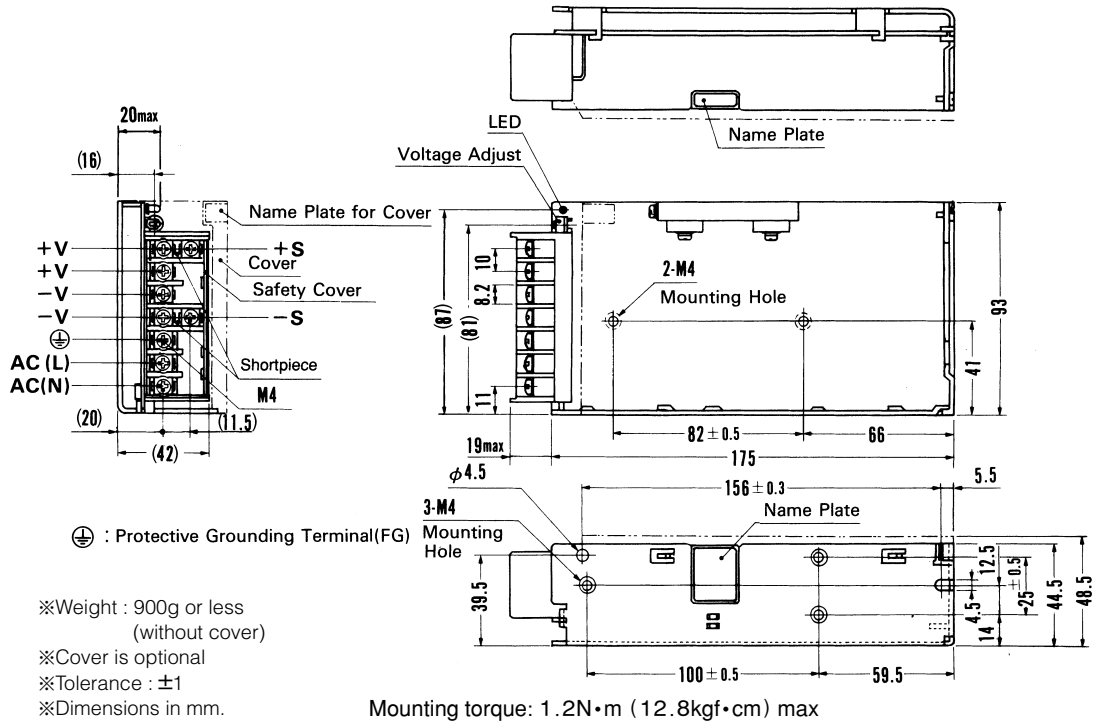

Performance data

■ STATIC CHARACTERISTICS (R150U-5)

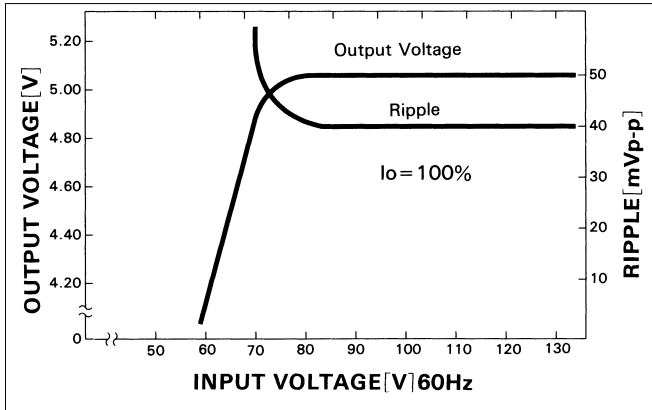

■ RISE TIME & FALL TIME (R150U-5)

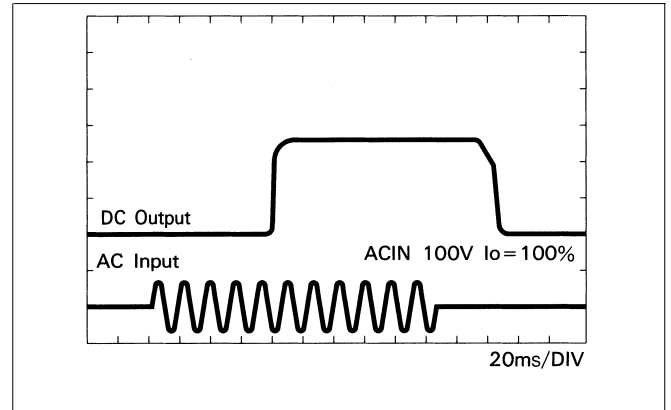

■ OVERCURRENT CHARACTERISTICS (R150U-5)

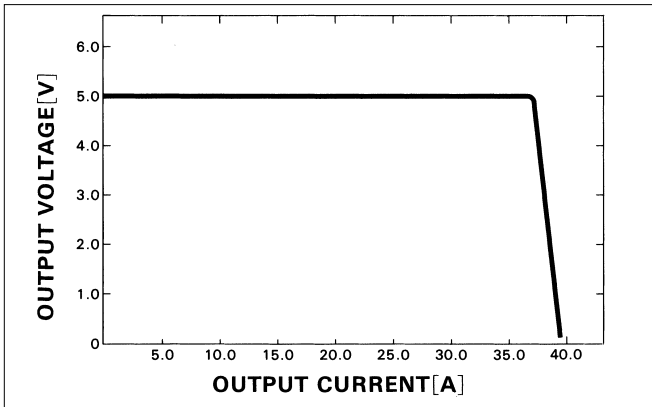

■ DERATING CURVE

