

COSEL|科索 TUNS300F28 **PDF**

COSEL

深圳创唯电子有限公司

<http://www.cosef.net>



Medical
electric
equipment



Power
Factor
Correction



World wide



Low Profile



Safety
Approvals



Inrush
current
limiting



Isolated



OCP



OVP



Remote
ON/OFF



Parallel
Operation

TUNS-series

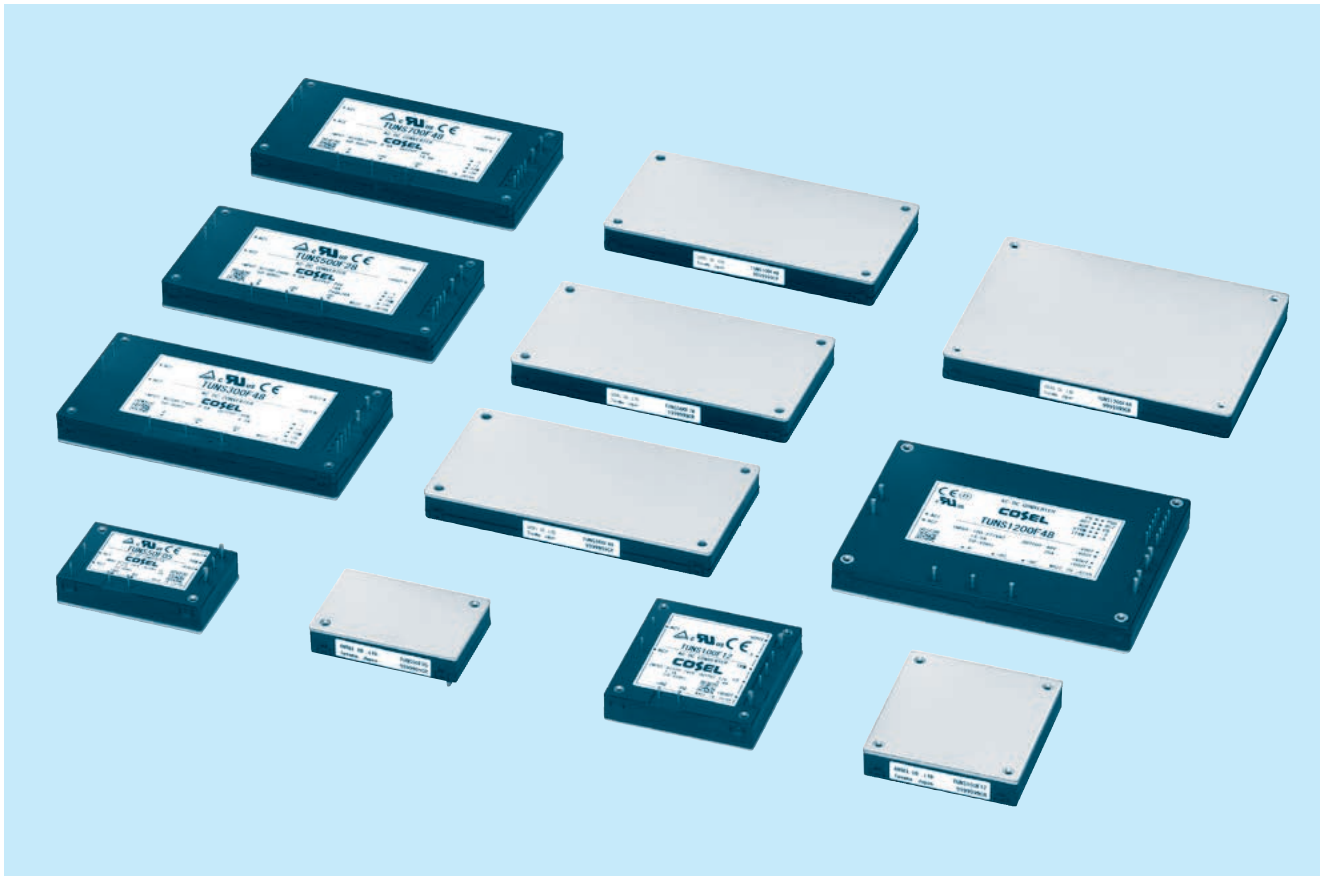

Feature

AC-DC Power Module Type Converter
 Harmonic attenuator (Complies with IEC61000-3-2 class A)
 Thin and small size
 Built-in overcurrent, overvoltage and thermal protection circuits
 Mounting hole (M3 tapped)

<TUNS50F/100F/300F/500F/700F>
 Universal input 85 - 264VAC
 Peak current (TUNS500F)

<TUNS1200F>
 Wide input 85 - 305VAC
 For medical electric equipment
 Constant current regulation
 Output voltage can be varied to near 0V
 Parallel operation possible

CE marking

Low voltage directive
 RoHS Directive

Safety Approval

UL60950-1, C-UL, EN60950-1
 (TUNS50F/100F/300F/500F/700F)
 UL62368-1, C-UL, EN62368-1 (TUNS1200F)
 ANSI/AAMI ES60601-1, EN60601-1 3rd (TUNS1200F)

5-year warranty

Optional parts

Heat sink

TUNS50F

TUN S 50 F 05 -□
 ① ② ③ ④ ⑤ ⑥



*Providing heat sink as option

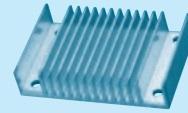

- ① Series name
- ② Single output
- ③ Output wattage
- ④ Universal Input
- ⑤ Output voltage
- ⑥ Optional
T : with Mounting hole (φ 3.4 thru)

*Avoid short circuit between +BC and -BC. It may cause the failure of inside components.
 *Keep TRM open, if output voltage adjustment is not necessary.

MODEL	TUNS50F05	TUNS50F12	TUNS50F24
MAX OUTPUT WATTAGE[W]	50.0	50.4	50.4
DC OUTPUT	5V 10A	12V 4.2A	24V 2.1A

SPECIFICATIONS

	MODEL	TUNS50F05	TUNS50F12	TUNS50F24	
INPUT	VOLTAGE[V]	AC85 - 264 1 φ (Refer to "Derating")			
	CURRENT[A]	ACIN 100V	0.67typ (Io=100%)		
		ACIN 200V	0.35typ (Io=100%)		
	FREQUENCY[Hz]	50/60 (47 - 63)			
	EFFICIENCY[%]	ACIN 100V	79typ	83typ	84typ
		ACIN 200V	81typ	84typ	86typ
	POWER FACTOR (Io=100%)	ACIN 100V	0.95typ		
		ACIN 200V	0.90typ		
INRUSH CURRENT	Limited by external components (Thermistor)				
LEAKAGE CURRENT[mA]	0.75max (ACIN 240V 60Hz, Io=100%, According to IEC60950-1)				
OUTPUT	VOLTAGE[V]	5	12	24	
	CURRENT[A]	10	4.2	2.1	
	LINE REGULATION[mV]	10max	24max	48max	
	LOAD REGULATION[mV]	10max	24max	48max	
	RIPPLE[mVp-p]	0 to +100°C *1	80max	120max	120max
		-40 to 0°C *1	120max	150max	150max
		0 to 15% Load *1	200max	280max	380max
	RIPPLE NOISE[mVp-p]	0 to +100°C *1	120max	150max	150max
		-40 to 0°C *1	200max	200max	250max
		0 to 15% Load *1	280max	360max	460max
	TEMPERATURE REGULATION[mV]	0 to +65°C	50max	120max	240max
		-40 to +100°C	100max	240max	480max
	DRIFT[mV]	*2	20max	40max	90max
OUTPUT VOLTAGE ADJUSTMENT RANGE[V]	Fixed (TRM pin open), adjustable by external resistor or external signal				
	4.50 - 6.00	10.80 - 13.20	21.60 - 26.40		
OUTPUT VOLTAGE SETTING[V]	4.97 - 5.13	11.91 - 12.29	23.62 - 24.38		
PROTECTION CIRCUIT AND OTHERS	OVERCURRENT PROTECTION	Works over 105% of rating and recovers automatically			
	OVERVOLTAGE PROTECTION[V]	6.30 - 7.00	13.90 - 16.35	27.60 - 32.40	
	REMOTE SENSING	Not provided			
	REMOTE ON/OFF	Not provided			
ISOLATION	INPUT-OUTPUT	AC3,000V 1minute, Cutoff current = 10mA, DC500V 50MΩ min (20±15°C)			
	INPUT-FG	AC2,000V 1minute, Cutoff current = 10mA, DC500V 50MΩ min (20±15°C)			
	OUTPUT-FG	AC500V 1minute, Cutoff current = 100mA, DC500V 50MΩ min (20±15°C)			
ENVIRONMENT	OPERATING TEMP., HUMID. AND ALTITUDE	-40 to +100°C (On aluminum base plate), 20 - 95%RH (Non condensing) (Refer to "Derating"), 3,000m (10,000 feet) max			
	STORAGE TEMP., HUMID. AND ALTITUDE	-40 to +100°C, 20 - 95%RH (Non condensing), 9,000m (30,000 feet) max			
	VIBRATION	10 - 55Hz, 49.0m/s ² (5G), 3minutes period, 60minutes each along X, Y and Z axis			
	IMPACT	196.1m/s ² (20G), 11ms, once each along X, Y and Z axis			
SAFETY AND NOISE REGULATIONS	AGENCY APPROVALS	UL60950-1, C-UL (CSA60950-1), EN60950-1, EN50178			
	HARMONIC ATTENUATOR	Complies with IEC61000-3-2 (Class A) *3			
OTHERS	CASE SIZE/WEIGHT	58.4 X 12.7 X 37.3mm [2.3 X 0.5 X 1.47 inches] (W X H X D) / 80g max			
	COOLING METHOD	Conduction cooling (e.g. heat radiation from the aluminum base plate to the attached heat sink)			

*1 Refer to instruction manual for measuring method of electric characteristics.
 *2 Drift is the change in DC output for an eight hour period after a half-hour warm-up at 25°C, with the input voltage held constant at the rated input/output.
 *3 Please contact us about another class.

External view

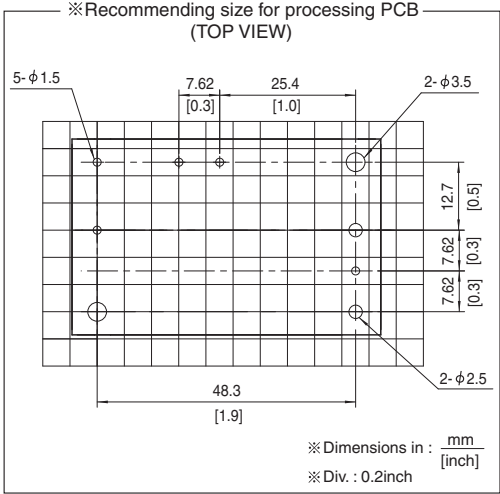
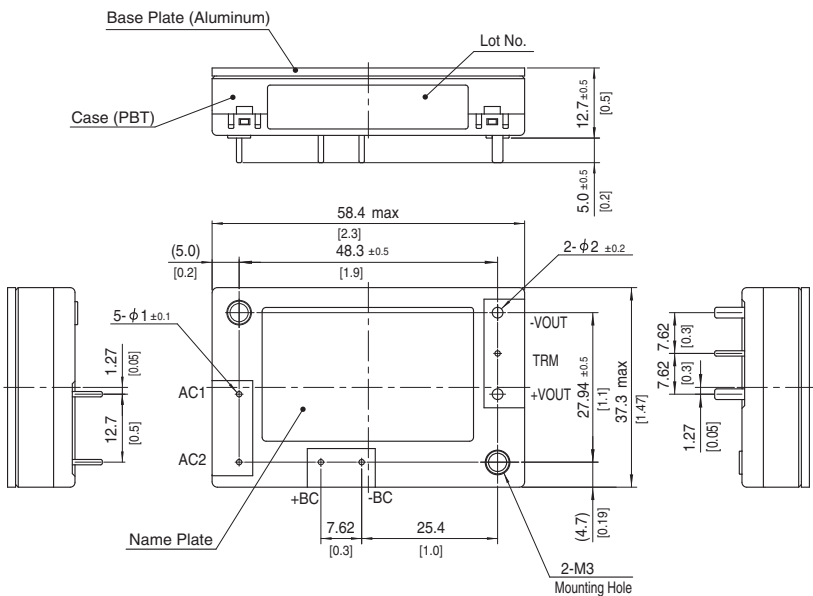

- ※ Tolerance : ±0.3 [±0.012]
- ※ Weight : 80g max
- ※ Dimensions in mm, []=inches
- ※ Mounting hole screwing torque : 0.49N · m (5.0kgf · cm) max

TUNS100F

TUN S 100 F 05 -□

① ② ③ ④ ⑤ ⑥

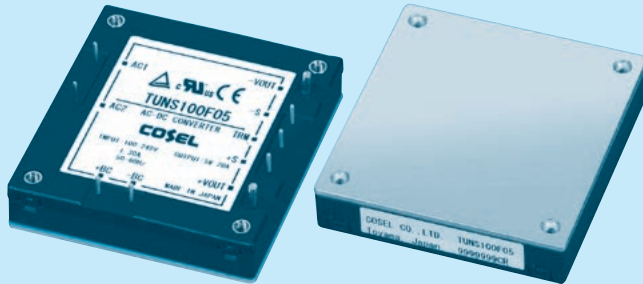

*Providing heat sink as option

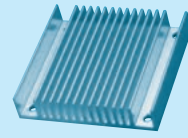

- ① Series name
- ② Single output
- ③ Output wattage
- ④ Universal Input
- ⑤ Output voltage
- ⑥ Optional
- T : with Mounting hole (φ 3.4 thru)

- *Avoid short circuit between +BC and -BC. It may cause the failure of inside components.
- *Keep TRM open, if output voltage adjustment is not necessary.
- *If remote sensing is not necessary, connect between +Vout & +S and between -Vout & -S.

MODEL	TUNS100F05	TUNS100F12	TUNS100F24
MAX OUTPUT WATTAGE[W]	100.0	100.8	100.8
DC OUTPUT	5V 20A	12V 8.4A	24V 4.2A

SPECIFICATIONS

	MODEL	TUNS100F05	TUNS100F12	TUNS100F24	
INPUT	VOLTAGE[V]	AC85 - 264 1 φ (Refer to "Derating")			
	CURRENT[A]	ACIN 100V	1.3typ (Io=100%)		
		ACIN 200V	0.7typ (Io=100%)		
	FREQUENCY[Hz]	50/60 (47 - 63)			
	EFFICIENCY[%]	ACIN 100V	82typ	83typ	84typ
		ACIN 200V	85typ	85typ	86typ
	POWER FACTOR (Io=100%)	ACIN 100V	0.95typ		
		ACIN 200V	0.90typ		
INRUSH CURRENT	Limited by external components (Thermistor)				
LEAKAGE CURRENT[mA]	0.75max (ACIN 240V 60Hz, Io=100%, According to IEC60950-1)				
OUTPUT	VOLTAGE[V]	5	12	24	
	CURRENT[A]	20	8.4	4.2	
	LINE REGULATION[mV]	10max	24max	48max	
	LOAD REGULATION[mV]	10max	24max	48max	
	RIPPLE[mVp-p]	0 to +100°C *1	80max	120max	120max
		-40 to 0°C *1	120max	150max	150max
		0 to 15% Load *1	160max	240max	240max
	RIPPLE NOISE[mVp-p]	0 to +100°C *1	120max	150max	150max
		-40 to 0°C *1	200max	200max	250max
		0 to 15% Load *1	240max	300max	300max
	TEMPERATURE REGULATION[mV]	0 to +65°C	50max	120max	240max
-40 to +100°C		100max	240max	480max	
DRIFT[mV]	*2	20max	40max	90max	
OUTPUT VOLTAGE ADJUSTMENT RANGE[V]	Fixed (TRM pin open), adjustable by external resistor or external signal				
OUTPUT VOLTAGE SETTING[V]	4.50 - 6.00	10.80 - 13.20	21.60 - 26.40		
	4.97 - 5.13	11.91 - 12.29	23.62 - 24.38		
PROTECTION CIRCUIT AND OTHERS	OVERCURRENT PROTECTION	Works over 105% of rating and recovers automatically			
	OVERVOLTAGE PROTECTION[V]	6.30 - 7.00	13.90 - 16.35	27.60 - 32.40	
	REMOTE SENSING	Provided			
	REMOTE ON/OFF	Not provided			
ISOLATION	INPUT-OUTPUT	AC3,000V 1minute, Cutoff current = 10mA, DC500V 50MΩ min (20±15°C)			
	INPUT-FG	AC2,000V 1minute, Cutoff current = 10mA, DC500V 50MΩ min (20±15°C)			
	OUTPUT-FG	AC500V 1minute, Cutoff current = 100mA, DC500V 50MΩ min (20±15°C)			
ENVIRONMENT	OPERATING TEMP., HUMID. AND ALTITUDE	-40 to +100°C (On aluminum base plate), 20 - 95%RH (Non condensing) (Refer to "Derating"), 3,000m (10,000 feet) max			
	STORAGE TEMP., HUMID. AND ALTITUDE	-40 to +100°C, 20 - 95%RH (Non condensing), 9,000m (30,000 feet) max			
	VIBRATION	10 - 55Hz, 49.0m/s ² (5G), 3minutes period, 60minutes each along X, Y and Z axis			
	IMPACT	196.1m/s ² (20G), 11ms, once each along X, Y and Z axis			
SAFETY AND NOISE REGULATIONS	AGENCY APPROVALS	UL60950-1, C-UL (CSA60950-1), EN60950-1, EN50178			
	HARMONIC ATTENUATOR	Complies with IEC61000-3-2 (Class A) *3			
OTHERS	CASE SIZE/WEIGHT	58.4 X 12.7 X 61.0mm [2.3 X 0.5 X 2.4 inches] (W X H X D) / 120g max			
	COOLING METHOD	Conduction cooling (e.g. heat radiation from the aluminum base plate to the attached heat sink)			

*1 Refer to instruction manual for measuring method of electric characteristics.

*2 Drift is the change in DC output for an eight hour period after a half-hour warm-up at 25°C, with the input voltage held constant at the rated input/output.

*3 Please contact us about another class.

External view

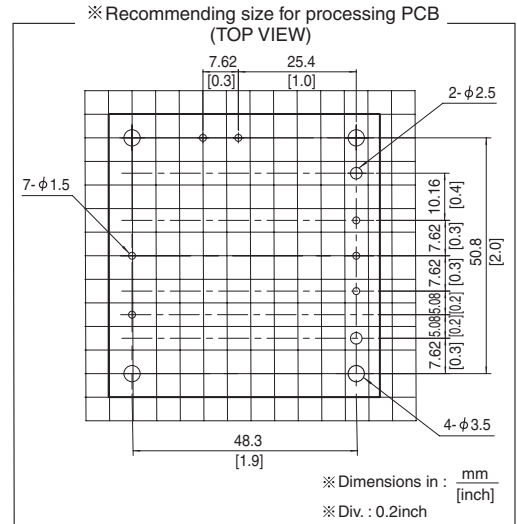
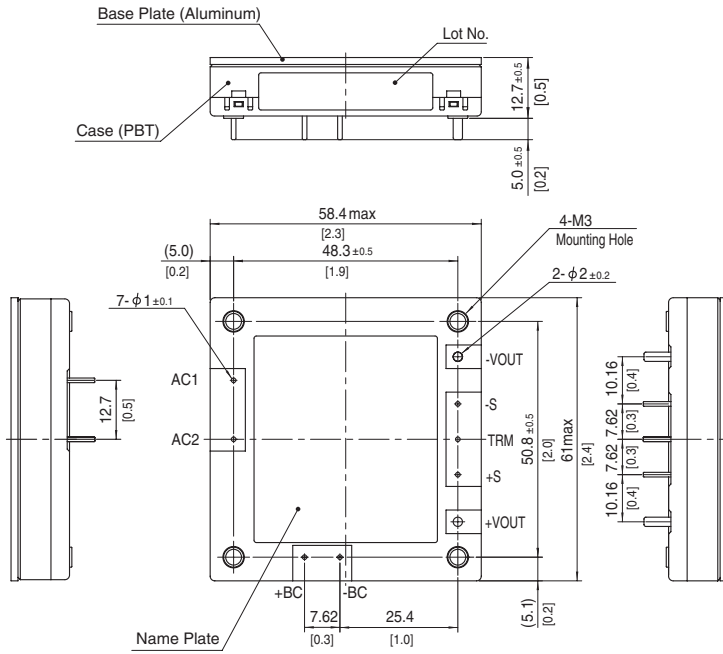

- ※ Tolerance : ± 0.3 [± 0.012]
- ※ Weight : 120g max
- ※ Dimensions in mm, []=inches
- ※ Mounting hole screwing torque : $0.49\text{N} \cdot \text{m}$ (5.0kgf · cm) max

TUNS300F

TUN S 300 F 48 -□

① ② ③ ④ ⑤ ⑥

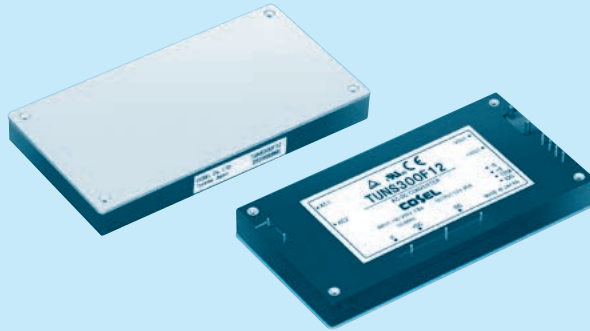
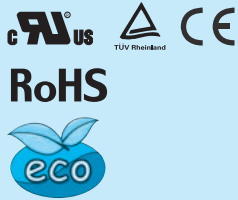

- ① Series name
- ② Single output
- ③ Output wattage
- ④ Universal Input
- ⑤ Output voltage
- ⑥ Optional
 - T : with Mounting hole (φ 3.4 thru)
 - Y1: Output voltage adjustment range ±20% (Only 48V)
 - R1: with Remote ON/OFF (Negative logic control)
 - R2: with Remote ON/OFF (Negative logic and Low standby power)
 - R3: with Remote ON/OFF (Positive logic control)
 - N1: Auto restart from thermal protection

* Avoid short circuit between +BC/R and -BC. It may cause the failure of inside components.
 * Keep TRM open, if output voltage adjustment is not necessary.
 * If remote sensing is not necessary, connect between +Vout & +S and between -Vout & -S.

MODEL	TUNS300F12	TUNS300F28	TUNS300F48
MAX OUTPUT WATTAGE[W]	300	308	312
DC OUTPUT	12V 25A	28V 11A	48V 6.5A

SPECIFICATIONS

	MODEL	TUNS300F12	TUNS300F28	TUNS300F48	
INPUT	VOLTAGE[V]	AC85 - 264 1 φ			
	CURRENT[A]	ACIN 100V	3.6typ (Io=100%)		
		ACIN 200V	1.8typ (Io=100%)		
	FREQUENCY[Hz]	50/60 (47 - 63)			
	EFFICIENCY[%]	ACIN 100V	84typ	87typ	87typ
		ACIN 200V	86typ	89typ	90typ
	POWER FACTOR (Io=100%)	ACIN 100V	0.96typ		
		ACIN 200V	0.93typ		
	INRUSH CURRENT	Limited by external resistance			
	LEAKAGE CURRENT[ma]	0.75max (ACIN 240V 60Hz, Io=100%, According to IEC60950-1)			
OUTPUT	VOLTAGE[V]	12	28	48	
	CURRENT[A]	25	11	6.5	
	LINE REGULATION[mV]	24max	56max	96max	
	LOAD REGULATION[mV]	24max	56max	96max	
	RIPPLE[mVp-p]	0 to +100°C*1	120max	180max	250max
		-40 to 0°C*1	150max	200max	300max
	RIPPLE NOISE[mVp-p]	0 to +100°C*1	150max	200max	300max
		-40 to 0°C*1	200max	300max	450max
	TEMPERATURE REGULATION[mV]	0 to +65°C	120max	280max	480max
		-40 to +100°C	240max	560max	960max
DRIFT[mV]	*2	40max	90max	180max	
OUTPUT VOLTAGE ADJUSTMENT RANGE[V]	Fixed (TRM pin open), adjustable by external resistor or external signal 9.60 - 14.40				
OUTPUT VOLTAGE SETTING[V]	11.91 - 12.29	22.40 - 33.60	38.40 - 52.80 (-Y1 Option : 38.4 - 57.6)		
PROTECTION CIRCUIT AND OTHERS	OVERCURRENT PROTECTION	Works over 105% of rating and recovers automatically			
	OVERVOLTAGE PROTECTION[V]	15.00 - 16.80	35.00 - 39.20	55.20 - 64.80 (-Y1 Option : 60.0 - 67.2)	
	REMOTE SENSING	Provided			
REMOTE ON/OFF	Optional (External power supply is required)				
ISOLATION	INPUT-OUTPUT · RC	*4	AC3,000V 1minute, Cutoff current = 10mA, DC500V 50MΩ min (20±15°C)		
	INPUT-FG		AC2,000V 1minute, Cutoff current = 10mA, DC500V 50MΩ min (20±15°C)		
	OUTPUT · RC-FG	*4	AC500V 1minute, Cutoff current = 100mA, DC500V 50MΩ min (20±15°C)		
	OUTPUT-RC	*4	AC100V 1minute, Cutoff current = 100mA, DC100V 10MΩ min (20±15°C)		
ENVIRONMENT	OPERATING TEMP., HUMID. AND ALTITUDE	-40 to +100°C (On aluminum base plate), 20 - 95%RH (Non condensing) (Refer to "Derating"), 3,000m (10,000 feet) max			
	STORAGE TEMP., HUMID. AND ALTITUDE	-40 to +100°C, 20 - 95%RH (Non condensing), 9,000m (30,000 feet) max			
	VIBRATION	10 - 55Hz, 49.0m/s ² (5G), 3minutes period, 60minutes each along X, Y and Z axis			
	IMPACT	196.1m/s ² (20G), 11ms, once each along X, Y and Z axis			
SAFETY AND NOISE REGULATIONS	AGENCY APPROVALS	UL60950-1, C-UL (CSA60950-1), EN60950-1			
	HARMONIC ATTENUATOR	Complies with IEC61000-3-2 (Class A) *3			
OTHERS	CASE SIZE/WEIGHT	117.3 × 12.7 × 61.5mm [4.62 × 0.5 × 2.42 inches] (W × H × D) / 190g max			
	COOLING METHOD	Conduction cooling (e.g. heat radiation from the aluminum base plate to the attached heat sink)			

*1 Refer to instruction manual for measuring method of electric characteristics.
 *2 Drift is the change in DC output for an eight hour period after a half-hour warm-up at 25°C, with the input voltage held constant at the rated input/output.
 *3 Please contact us about another class.
 *4 "RC" is applicable when remote control (optional) is added.

External view

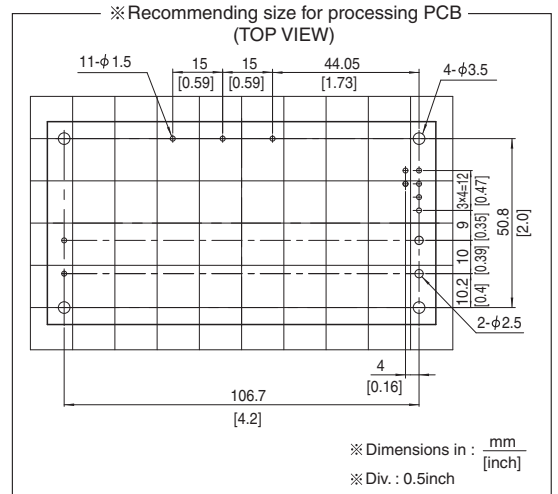
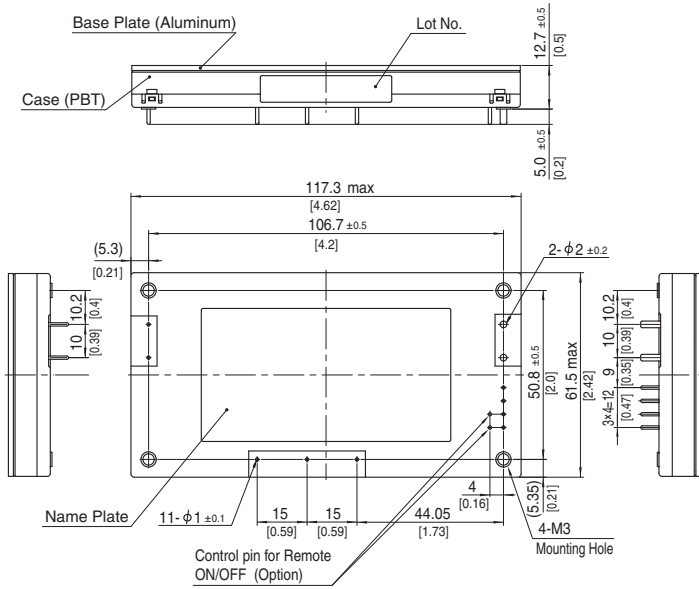

- ※ Tolerance : ±0.3 [±0.012]
- ※ Weight : 190g max
- ※ Dimensions in mm, []=inches
- ※ Mounting hole screwing torque : 0.49N · m (5.0kgf · cm) max

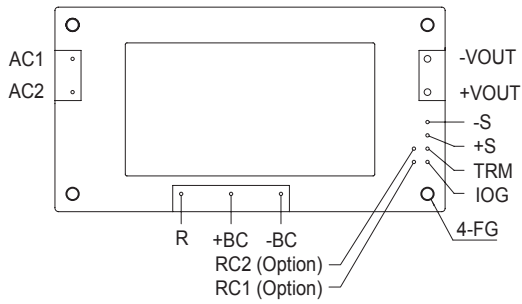

TUNS500F

TUN S 500 F 48 -□

① ② ③ ④ ⑤ ⑥

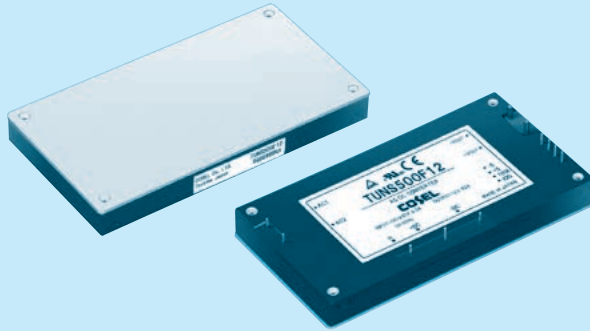
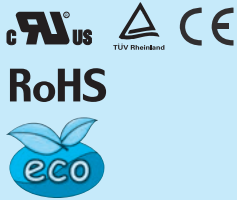

- ① Series name
- ② Single output
- ③ Output wattage
- ④ Universal Input
- ⑤ Output voltage
- ⑥ Optional
 - T : with Mounting hole (φ 3.4 thru)
 - Y1: Output voltage adjustment range ±20% (Only 48V)
 - R1: with Remote ON/OFF (Negative logic control)
 - R2: with Remote ON/OFF (Negative logic and Low standby power)
 - R3: with Remote ON/OFF (Positive logic control)
 - N1: Auto restart from thermal protection

* Avoid short circuit between +BC/R and -BC. It may cause the failure of inside components.
 * Keep TRM open, if output voltage adjustment is not necessary.
 * If remote sensing is not necessary, connect between +Vout & +S and between -Vout & -S.

MODEL	TUNS500F12	TUNS500F28	TUNS500F48
MAX OUTPUT WATTAGE[W]	504	504	504
DC OUTPUT	12V 42A (Peak 55A)	28V 18A (Peak 24A)	48V 10.5A (Peak 14A)

SPECIFICATIONS

	MODEL	TUNS500F12	TUNS500F28	TUNS500F48	
INPUT	VOLTAGE[V]	AC85 - 264 1 φ			
	CURRENT[A]	ACIN 100V	6.0typ (Io=100%)		
		ACIN 200V	3.0typ (Io=100%)		
	FREQUENCY[Hz]	50/60 (47 - 63)			
	EFFICIENCY[%]	ACIN 100V	84typ	87typ	88typ
		ACIN 200V	86typ	90typ	90.5typ
	POWER FACTOR (Io=100%)	ACIN 100V	0.96typ		
		ACIN 200V	0.93typ		
	INRUSH CURRENT	Limited by external resistance			
	LEAKAGE CURRENT[ma]	0.75max (ACIN 240V 60Hz, Io=100%, According to IEC60950-1)			
OUTPUT	VOLTAGE[V]	12	28	48	
	CURRENT[A]	*3 42 (Peak 55)	18 (Peak 24)	10.5 (Peak 14)	
	LINE REGULATION[mV]	24max	56max	96max	
	LOAD REGULATION[mV]	24max	56max	96max	
	RIPPLE[mVp-p]	0 to +100°C *1	120max	180max	250max
		-40 to 0°C *1	150max	200max	300max
	RIPPLE NOISE[mVp-p]	0 to +100°C *1	150max	200max	300max
		-40 to 0°C *1	200max	300max	450max
	TEMPERATURE REGULATION[mV]	0 to +65°C	120max	280max	480max
		-40 to +100°C	240max	560max	960max
DRIFT[mV]	*2 40max	90max	180max		
OUTPUT VOLTAGE ADJUSTMENT RANGE[V]	Fixed (TRM pin open), adjustable by external resistor or external signal 9.60 - 14.40				
OUTPUT VOLTAGE SETTING[V]	11.91 - 12.29	27.56 - 28.44	38.40 - 52.80 (-Y1 Option : 38.4 - 57.6)		
PROTECTION CIRCUIT AND OTHERS	OVERCURRENT PROTECTION	Works over 101% of peak current and recovers automatically			
	OVERVOLTAGE PROTECTION[V]	15.00 - 16.80	35.00 - 39.20	55.20 - 64.80 (-Y1 Option : 60.0 - 67.2)	
	REMOTE SENSING	Provided			
	REMOTE ON/OFF	Optional (External power supply is required)			
ISOLATION	INPUT-OUTPUT · RC	*5 AC3,000V 1minute, Cutoff current = 10mA, DC500V 50MΩ min (20±15°C)			
	INPUT-FG	AC2,000V 1minute, Cutoff current = 10mA, DC500V 50MΩ min (20±15°C)			
	OUTPUT · RC-FG	*5 AC500V 1minute, Cutoff current = 100mA, DC500V 50MΩ min (20±15°C)			
	OUTPUT-RC	*5 AC100V 1minute, Cutoff current = 100mA, DC100V 10MΩ min (20±15°C)			
ENVIRONMENT	OPERATING TEMP, HUMID. AND ALTITUDE	-40 to +100°C (On aluminum base plate), 20 - 95%RH (Non condensing) (Refer to "Derating"), 3,000m (10,000 feet) max			
	STORAGE TEMP, HUMID. AND ALTITUDE	-40 to +100°C, 20 - 95%RH (Non condensing), 9,000m (30,000 feet) max			
	VIBRATION	10 - 55Hz, 49.0m/s ² (5G), 3minutes period, 60minutes each along X, Y and Z axis			
	IMPACT	196.1m/s ² (20G), 11ms, once each along X, Y and Z axis			
SAFETY AND NOISE REGULATIONS	AGENCY APPROVALS	UL60950-1, C-UL (CSA60950-1), EN60950-1			
	HARMONIC ATTENUATOR	Complies with IEC61000-3-2 (Class A) *4			
OTHERS	CASE SIZE/WEIGHT	117.3 × 12.7 × 61.5mm [4.62 × 0.5 × 2.42 inches] (W × H × D) / 190g max			
	COOLING METHOD	Conduction cooling (e.g. heat radiation from the aluminum base plate to the attached heat sink)			

*1 Refer to instruction manual for measuring method of electric characteristics.
 *2 Drift is the change in DC output for an eight hour period after a half-hour warm-up at 25°C, with the input voltage held constant at the rated input/output.
 *3 () means peak current. Avoid operating with peak current continuously. It may cause failure of the components inside the product. There are limitation of available condition of the peak current, such as peak time, duty etc. (Refer to the instruction manual in detail.)
 *4 Please contact us about another class.
 *5 "RC" is applicable when remote control (optional) is added.

External view

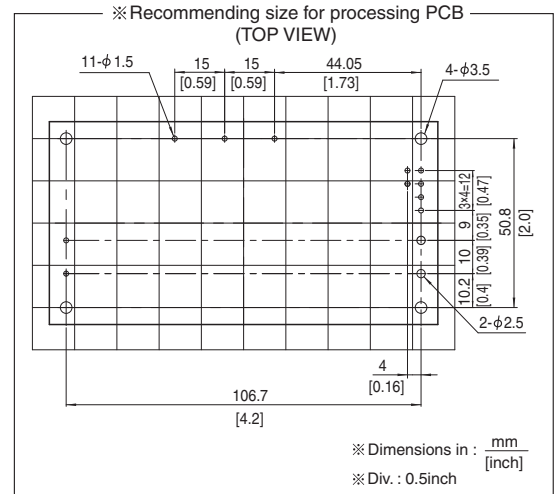
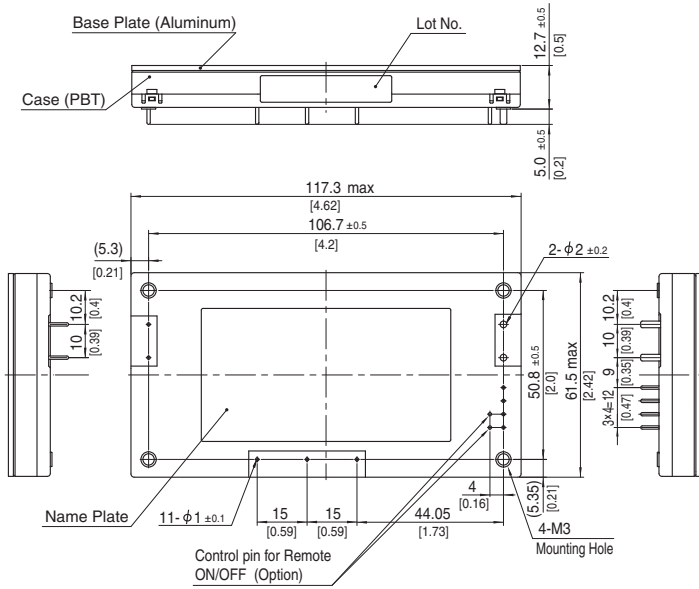

- ※ Tolerance : ±0.3 [±0.012]
- ※ Weight : 190g max
- ※ Dimensions in mm, []=inches
- ※ Mounting hole screwing torque : 0.49N · m (5.0kgf · cm) max

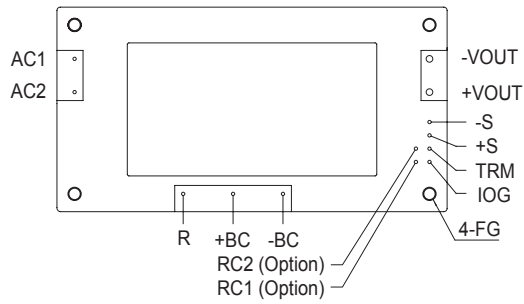

TUNS700F

TUN S 700 F 48 -□
 ① ② ③ ④ ⑤ ⑥

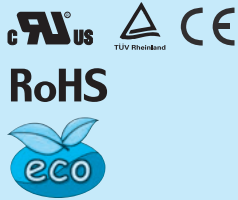

- ① Series name
- ② Single output
- ③ Output wattage
- ④ Universal Input
- ⑤ Output voltage
- ⑥ Optional
- T : with Mounting hole (φ 3.4 thru)
- Y1: Output voltage adjustment range ±20% (Only 48V)
- R1: with Remote ON/OFF (Negative logic control)
- R2: with Remote ON/OFF (Negative logic and Low standby power)
- R3: with Remote ON/OFF (Positive logic control)
- P : Parallel operation (Output voltage trimming disabled, Remote sensing disabled)

* Avoid short circuit between +BC/R and -BC. It may cause the failure of inside components.
 * Keep TRM open, if output voltage adjustment is not necessary.
 * If remote sensing is not necessary, connect between +Vout & +S and between -Vout & -S.

MODEL	TUNS700F12	TUNS700F28	TUNS700F48
MAX OUTPUT WATTAGE[W]	700.8	700.0	700.8
DC OUTPUT	12V 58.4A	28V 25A	48V 14.6A

SPECIFICATIONS

	MODEL	TUNS700F12	TUNS700F28	TUNS700F48	
INPUT	VOLTAGE[V]	AC85 - 264 1 φ			
	CURRENT[A]	ACIN 100V	8.6typ (Io=100%)		
		ACIN 200V	4.1typ (Io=100%)		
	FREQUENCY[Hz]	50/60 (47 - 63)			
	EFFICIENCY[%]	ACIN 100V	83typ	86typ	87typ
		ACIN 200V	86typ	89typ	90typ
	POWER FACTOR (Io=100%)	ACIN 100V	0.96typ		
		ACIN 200V	0.93typ		
INRUSH CURRENT	Limited by external resistance				
LEAKAGE CURRENT[ma]	0.75max (ACIN 240V 60Hz, Io=100%, According to IEC60950-1)				
OUTPUT	VOLTAGE[V]	12	28	48	
	CURRENT[A]	58.4	25	14.6	
	LINE REGULATION[mV]	24max	56max	96max	
	LOAD REGULATION[mV]	24max	56max	96max	
	RIPPLE[mVp-p]	0 to +100°C *1	120max	180max	250max
		-40 to 0°C *1	150max	200max	300max
	RIPPLE NOISE[mVp-p]	0 to +100°C *1	150max	200max	300max
		-40 to 0°C *1	200max	300max	450max
	TEMPERATURE REGULATION[mV]	0 to +65°C	120max	280max	480max
		-40 to +100°C	240max	560max	960max
	DRIFT[mV]	*2 40max	90max	180max	
	OUTPUT VOLTAGE ADJUSTMENT RANGE[V]	Fixed (TRM pin open), adjustable by external resistor or external signal			
OUTPUT VOLTAGE SETTING[V]	9.60 - 14.40	22.40 - 33.60	38.40 - 52.80 (-Y1 Option : 38.4 - 57.6)		
	11.91 - 12.29	27.56 - 28.44	47.24 - 48.76		
PROTECTION CIRCUIT AND OTHERS	OVERCURRENT PROTECTION	Works over 105% of rating and recovers automatically			
	OVERVOLTAGE PROTECTION[V]	15.00 - 16.80	35.00 - 39.20	55.20 - 64.80 (-Y1 Option : 60.0 - 67.2)	
	REMOTE SENSING	Provided			
	REMOTE ON/OFF	Optional (External power supply is required)			

MODEL	TUNS700F12-P	TUNS700F28-P	TUNS700F48-P
MAX OUTPUT WATTAGE[W]	700.8	700.0	700.8
DC OUTPUT	12V 58.4A	28V 25A	48V 14.6A

SPECIFICATIONS

	MODEL	TUNS700F12-P	TUNS700F28-P	TUNS700F48-P	
INPUT	VOLTAGE[V]	AC85 - 264 1 φ			
	CURRENT[A]	ACIN 100V	8.6typ (Io=100%)		
		ACIN 200V	4.1typ (Io=100%)		
	FREQUENCY[Hz]	50/60 (47 - 63)			
	EFFICIENCY[%]	ACIN 100V	83typ	86typ	87typ
		ACIN 200V	86typ	89typ	90typ
	POWER FACTOR (Io=100%)	ACIN 100V	0.96typ		
		ACIN 200V	0.93typ		
INRUSH CURRENT	Limited by external resistance				
LEAKAGE CURRENT[ma]	0.75max (ACIN 240V 60Hz, Io=100%, According to IEC60950-1)				
OUTPUT	VOLTAGE[V]	12	28	48	
	CURRENT[A]	58.4	25	14.6	
	VOLTAGE ACCURACY[%]	+5, -3	+5, -3	+5, -3	
	RIPPLE[mVp-p]	0 to +100°C *1	240max	360max	600max
		-40 to 0°C *1	300max	400max	700max
	RIPPLE NOISE[mVp-p]	0 to +30% Load *1	360max	540max	900max
		0 to +100°C *1	300max	400max	700max
	RIPPLE NOISE[mVp-p]	-40 to 0°C *1	400max	600max	1000max
		0 to +30% Load *1	450max	600max	1000max
	PROTECTION CIRCUIT AND OTHERS	OVERCURRENT PROTECTION	Works over 105% of rating and recovers automatically		
		OVERVOLTAGE PROTECTION[V]	15.00 - 16.80	35.00 - 39.20	55.20 - 64.80
		REMOTE ON/OFF	Optional (External power supply is required)		

GENERAL SPECIFICATIONS

ISOLATION	INPUT-OUTPUT · RC	*4 AC3,000V 1minute, Cutoff current = 10mA, DC500V 50MΩ min (20±15°C)
	INPUT-FG	AC2,000V 1minute, Cutoff current = 10mA, DC500V 50MΩ min (20±15°C)
	OUTPUT · RC-FG	*4 AC500V 1minute, Cutoff current = 100mA, DC500V 50MΩ min (20±15°C)
	OUTPUT-RC	*4 AC100V 1minute, Cutoff current = 100mA, DC100V 10MΩ min (20±15°C)
ENVIRONMENT	OPERATING TEMP., HUMID. AND ALTITUDE	-40 to +100°C (On aluminum base plate), 20 - 95%RH (Non condensing) (Refer to "Derating"), 3,000m (10,000 feet) max
	STORAGE TEMP., HUMID. AND ALTITUDE	-40 to +100°C, 20 - 95%RH (Non condensing), 9,000m (30,000 feet) max
	VIBRATION	10 - 55Hz, 49.0m/s ² (5G), 3minutes period, 60minutes each along X, Y and Z axis
	IMPACT	196.1m/s ² (20G), 11ms, once each along X, Y and Z axis
SAFETY AND NOISE REGULATIONS	AGENCY APPROVALS	UL60950-1, C-UL (CSA60950-1), EN60950-1
	HARMONIC ATTENUATOR	Complies with IEC61000-3-2 (Class A) *3
OTHERS	CASE SIZE/WEIGHT	117.3×12.7×61.5mm [4.62×0.5×2.42 inches] (W×H×D) / 190g max
	COOLING METHOD	Conduction cooling (e.g. heat radiation from the aluminum base plate to the attached heat sink)

- *1 Refer to instruction manual for measuring method of electric characteristics.
- *2 Drift is the change in DC output for an eight hour period after a half-hour warm-up at 25°C, with the input voltage held constant at the rated input/output.
- *3 Please contact us about another class.
- *4 "RC" is applicable when remote control (optional) is added.

External view

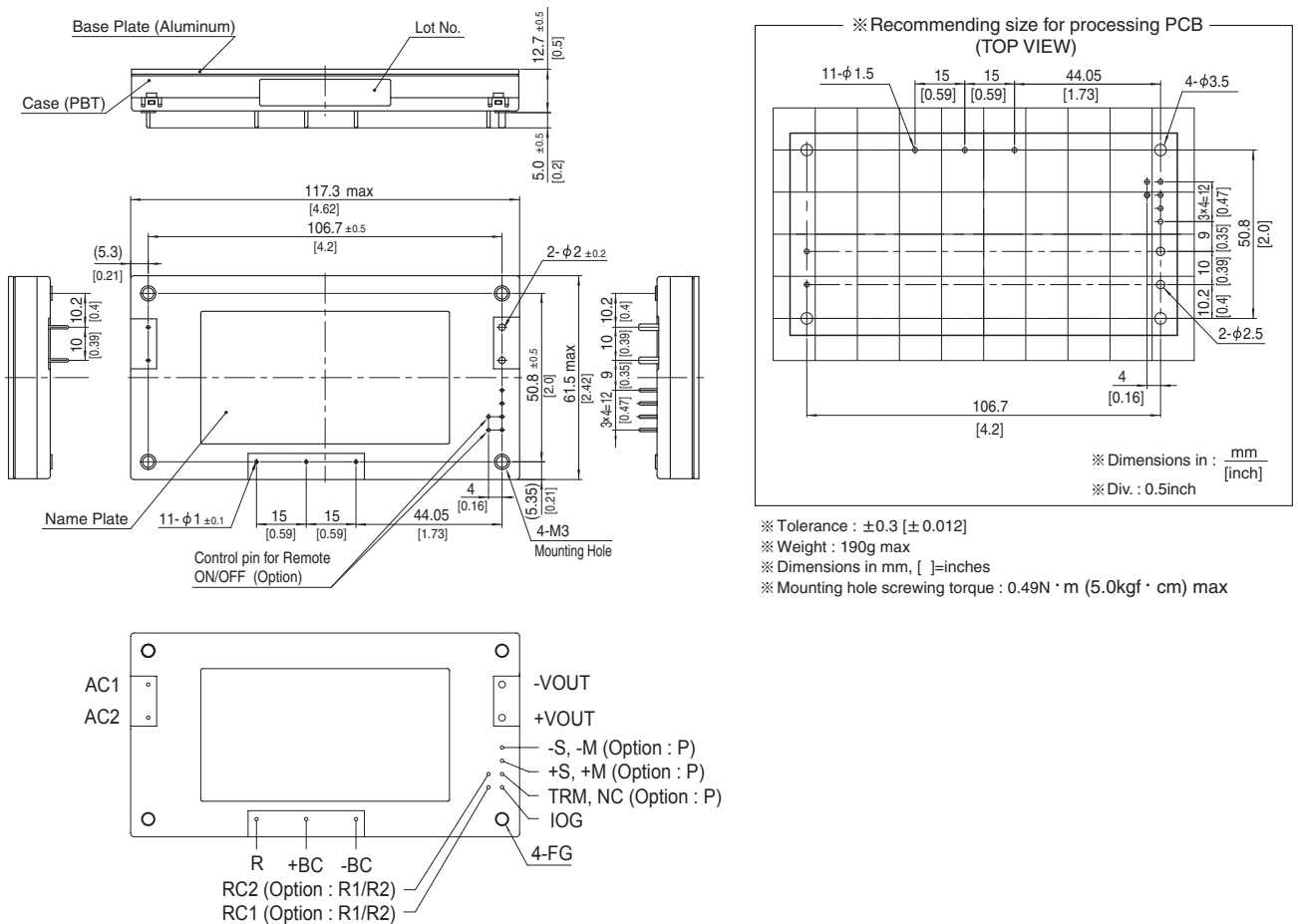

TUNS1200F

TUN S 1200 F 48 -□

① ② ③ ④ ⑤ ⑥

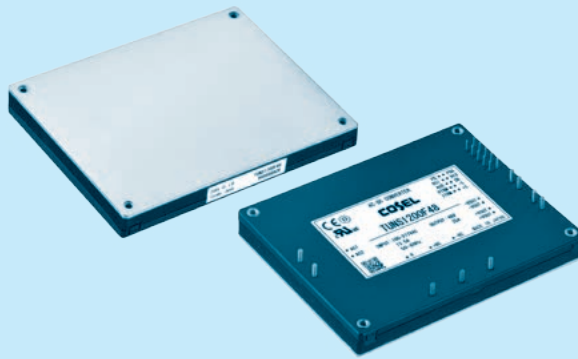

- ① Series name
- ② Single output
- ③ Output wattage
- ④ Universal Input
- ⑤ Output voltage
- ⑥ Optional
 - T : with Mounting hole (φ 3.4 thru)
 - Y1: Output voltage adjustment range ±20% (Only 48V)
 - R3: with Remote ON/OFF (Positive logic control)
 - N1: Auto restart from thermal protection

* Avoid short circuit between +BC/R and -BC. It may cause the failure of inside components.
 * Keep VTRM open, if output voltage adjustment is not necessary.
 * Keep ITRM open, if output current adjustment is not necessary.
 * If remote sensing is not necessary, connect between +Vout & +S and between -Vout & -S.

MODEL	TUNS1200F12	TUNS1200F28	TUNS1200F48
MAX OUTPUT WATTAGE[W]	1008	1204	1200
DC OUTPUT	12V 84A	28V 43A	48V 25A

SPECIFICATIONS

	MODEL	TUNS1200F12	TUNS1200F28	TUNS1200F48	
INPUT	VOLTAGE[V]	AC85 - 305V 1 φ			
	CURRENT[A]	ACIN 100V	12typ	14typ	14typ
		ACIN 200V	5.9typ	6.7typ	6.6typ
	FREQUENCY[Hz]	50/60 (47 - 63)			
	EFFICIENCY[%]	ACIN 100V	85typ	89typ	90typ
		ACIN 200V	87typ	91typ	92typ
	POWER FACTOR (I _o =100%)	ACIN 100V	0.98typ		
		ACIN 200V	0.95typ		
INRUSH CURRENT	Limited by external resistance				
LEAKAGE CURRENT[mA]	0.5max (ACIN 240V 60Hz, I _o =100%, According to IEC60601-1)				
OUTPUT	VOLTAGE[V]	12	28	48	
	CURRENT[A]	84	43	25	
	LINE REGULATION[mV]	24max	56max	96max	
	LOAD REGULATION[mV]	24max	56max	96max	
	RIPPLE[mVp-p]	0 to +100°C *1	150max	180max	250max
		-40 to 0°C *1	180max	200max	300max
	RIPPLE NOISE[mVp-p]	0 to +100°C *1	180max	200max	300max
		-40 to 0°C *1	200max	300max	450max
	TEMPERATURE REGULATION[mV]	0 to +80°C *1	120max	280max	480max
		-40 to +100°C *1	240max	560max	960max
	DRIFT[mV]	*2 40max	90max	180max	
OUTPUT VOLTAGE ADJUSTMENT RANGE[V]	Fixed (TRM pin open), adjustable by external resistor or external signal 9.60 - 14.40 22.40 - 33.60 38.40 - 52.80 (-Y1 Option : 38.4 - 57.6)				
OUTPUT VOLTAGE SETTING[V]	11.91 - 12.29	27.56 - 28.44	47.24 - 48.76		
PROTECTION CIRCUIT AND OTHERS	OVERCURRENT PROTECTION	Works over 105% of rating and recovers automatically			
	OVERVOLTAGE PROTECTION[V]	15.00 - 16.80	35.00 - 39.20	55.20 - 60.00 (-Y1 Option : 60.0 - 67.2)	
	REMOTE SENSING	Provided			
	REMOTE ON/OFF	Provided			
ISOLATION	INPUT-OUTPUT	AC3,000V 1minute, Cutoff current = 10mA, DC500V 50MΩ min (20±15°C) 2MOOP			
	INPUT-FG	AC2,000V 1minute, Cutoff current = 10mA, DC500V 50MΩ min (20±15°C) 1MOOP			
	OUTPUT-FG	AC500V 1minute, Cutoff current = 100mA, DC500V 50MΩ min (20±15°C)			
	OUTPUT-RC, PG	AC100V 1minute, Cutoff current = 100mA, DC100V 10MΩ min (20±15°C)			
ENVIRONMENT	OPERATING TEMP, HUMID. AND ALTITUDE	-40 to +100°C (On aluminum base plate), 20 - 95%RH (Non condensing) (Refer to DERATING CURVE)			
	STORAGE TEMP, HUMID. AND ALTITUDE	-40 to +100°C, 20 - 95%RH (Non condensing), 9,000m (30,000 feet) max			
	VIBRATION	10 - 55Hz, 49.0m/s ² (5G), 3minutes period, 60minutes each along X, Y and Z axis			
	IMPACT	196.1m/s ² (20G), 11ms, once each along X, Y and Z axis			
SAFETY AND NOISE REGULATIONS	AGENCY APPROVALS	UL62368-1, EN62368-1, C-UL (equivalent to CAN/CSA-C22.2 No.62368-1), ANSI/AAMI ES60601-1, EN60601-1 3rd, C-UL (equivalent to CAN/CSA-C22.2 No.60601-1), Complies with IEC60601-1-2 4th			
	HARMONIC ATTENUATOR	Complies with IEC61000-3-2 (Class A) *3			
OTHERS	CASE SIZE/WEIGHT	117.3 × 12.7 × 86.8mm [4.62 × 0.5 × 3.42 inches] (W × H × D) / 280g max			
	COOLING METHOD	Conduction cooling (e.g. heat radiation from the aluminum base plate to the attached heat sink)			

*1 Refer to instruction manual for measuring method of electric characteristics.

*2 Drift is the change in DC output for an eight hour period after a half-hour warm-up at 25°C, with the input voltage held constant at the rated input/output.

*3 Please contact us about another class.

External view

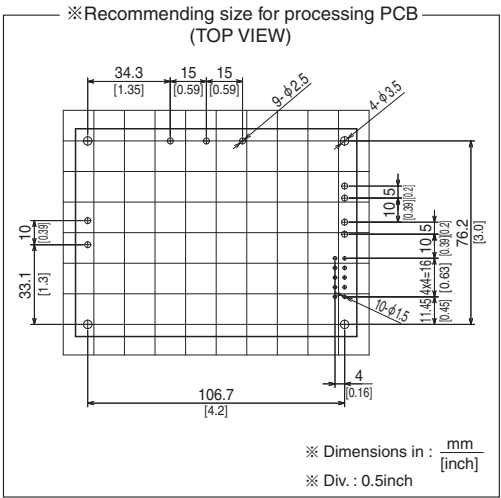
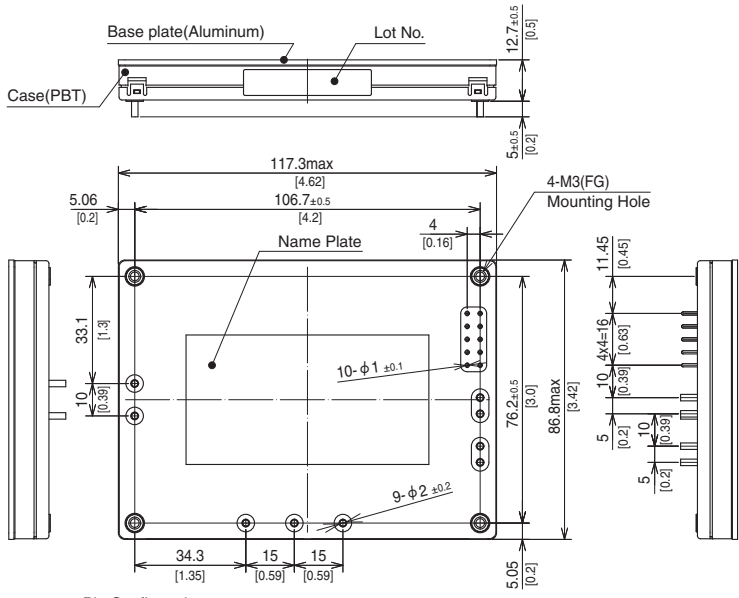

Pin Configuration

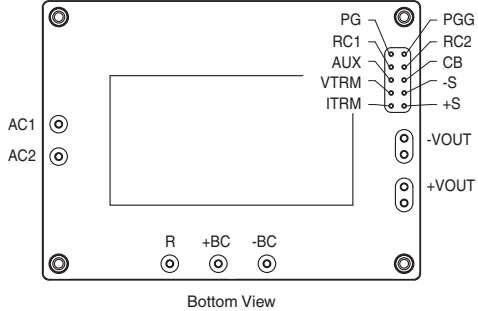

- ※ Tolerance : ±0.3 [±0.012]
- ※ Weight : 280g max
- ※ Dimensions in mm, []=inches
- ※ Mounting hole screwing torque : 0.49N · m (5.0kgf · cm) max

Pin Configuration

● TUNS50F

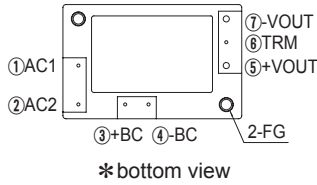

● TUNS100F

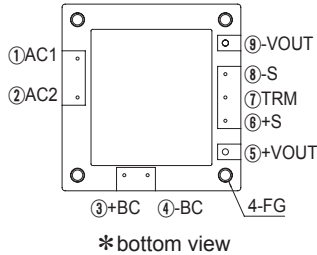

● TUNS300F/TUNS500F/TUNS700F

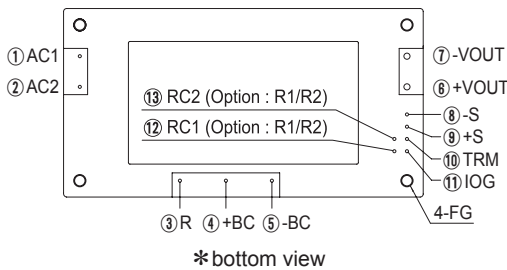

● TUNS700F□□-P (OPTION)

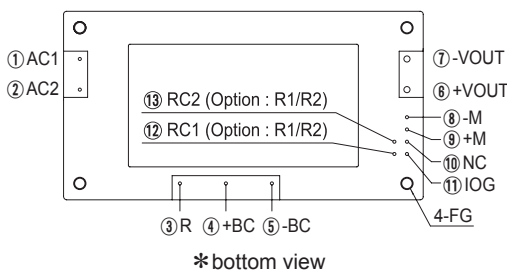

● TUNS1200F

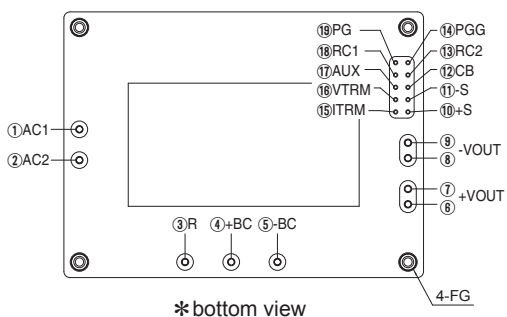

No.		Pin Connection	Function
TUNS50F	TUNS100F		
①	①	AC1	AC input
②	②	AC2	
③	③	+BC	+BC output
④	④	-BC	-BC output
⑤	⑤	+VOUT	+DC output
⑦	⑨	-VOUT	-DC output
-	⑧	-S	Remote sensing (-)
-	⑥	+S	Remote sensing (+)
⑥	⑦	TRM	Adjustment of output voltage
-	-	FG	Mounting hole (FG)

No.	Pin Connection	Function
①	AC1	AC input
②	AC2	
③	R	External resistor for inrush current protection
④	+BC	+BC output
⑤	-BC	-BC output
⑥	+VOUT	+DC output
⑦	-VOUT	-DC output
⑧	-S	Remote sensing (-)
⑨	+S	Remote sensing (+)
⑩	TRM	Adjustment of output voltage
⑪	IOG	Inverter operation monitor
⑫	RC1	Remote ON/OFF (Option)
⑬	RC2	Remote ON/OFF (Option)
-	FG	Mounting hole (FG)

No.	Pin Connection	Function
⑧	-M	Output voltage monitor terminal
⑨	+M	
⑩	NC	No connection

Other than the above are the same as standard products.

No.	Pin Connection	Function
①	AC1	AC input
②	AC2	
③	R	External resistor for inrush current protection
④	+BC	+BC output
⑤	-BC	-BC output
⑥⑦	+VOUT	+DC output
⑧⑨	-VOUT	-DC output
⑩	+S	Remote sensing (+)
⑪	-S	Remote sensing (-)
⑫	CB	Current balance
⑬	RC2	Remote ON/OFF ground
⑭	PGG	Power good output ground
⑮	ITRM	Adjustment of output current
⑯	VTRM	Adjustment of output voltage
⑰	AUX	Auxiliary output
⑱	RC1	Remote ON/OFF
⑲	PG	Power good output
-	FG	Mounting hole (FG)

Implementation • Mounting Method

Mounting method

- Use with the conduction cooling (e.g. heat dissipation from the aluminum base plate to the attached heat sink).
- Use a heat sink that larger than the power supply and has a large thickness so that the aluminum base plate can be cooled uniformly.
- The unit can be mounted in any direction. When two or more power supplies are used side by side, position them with proper intervals to allow enough air ventilation. Aluminum base plate temperature of each power supply should not exceed the temperature range shown in “derating”.
- Avoid placing the AC input line pattern layout underneath the unit. It will increase the line conducted noise. Make sure to leave an ample distance between the line pattern layout and the unit. Also avoid placing the DC output line pattern underneath the unit because it may increase the output noise. Lay out the pattern away from the unit.
- Avoid placing the signal line pattern layout underneath the unit because the power supply might become unstable. Lay out the pattern away from the unit.
- High-frequency noise radiates directly from the unit to the atmosphere. Therefore, design the shield pattern on the printed circuit board and connect it to FG or -BC. The shield pattern prevents noise radiation.
- When a heat sink cannot be fixed on the base plate side, order the power module with “-T” option. A heat sink can be mounted by affixing a M3 tap on the heat sink. Please make sure a mounting hole will be connected to a grounding capacitor CY.

	Mounting hole
Standard	M3 tapped
Optional : -T	φ 3.4 thru

Stress onto the pins

- When too much stress is applied to the pins may damage internal connections. Avoid applying stress in excess of that shown in right figure.
- The pins are soldered onto the internal PCB. Therefore, Do not bend or pull the leads with excessive force.
- Mounting hole diameter of PCB should be 3.5mm to reduce the stress to the pins.
- Fix the unit on PCB (fixing fittings) by screws to reduce the stress to the pins. Be sure to mount the unit first, then solder the unit.

● TUNS50F/100F/300F/500F/700F

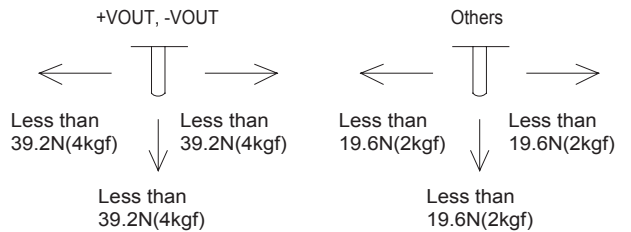

● TUNS1200F

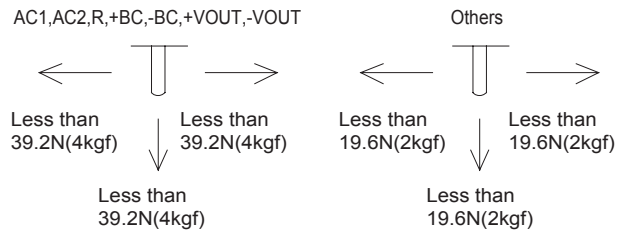

Soldering temperature

- Flow soldering : 260°C for up to 15 seconds.
- Soldering iron (26W) : 450°C for up to 5 seconds.

Derating

Input voltage derating curve

● TUNS50F/100F

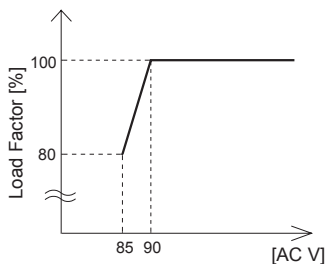

● TUNS700F/1200F

* TUNS1200F12 has no input voltage derating.

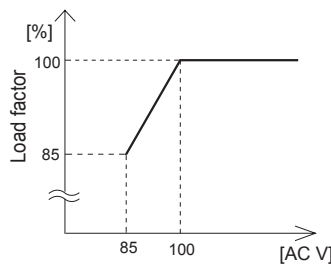

● TUNS300F/500F

* TUNS300F/500F has no input voltage derating.

Derating

Output voltage derating curve

■ Use the power modules with conduction cooling (e.g. heat dissipation from the aluminum base plate to the attached heat sink).

Below shows the derating curves with respect to the aluminum base plate temperature. Note that operation within the hatched areas will cause a significant level of ripple and ripple noise.

■ Please measure the temperature on the aluminum base plate edge side when you cannot measure the temperature of the center part of the aluminum base plate. In this case, please take 5deg temperature margin from the derating characteristics shown in below. Please reduce the temperature fluctuation range as much as possible when the up and down of the temperature are frequently generated. Contact us for more information on cooling methods.

● TUNS50F/100F

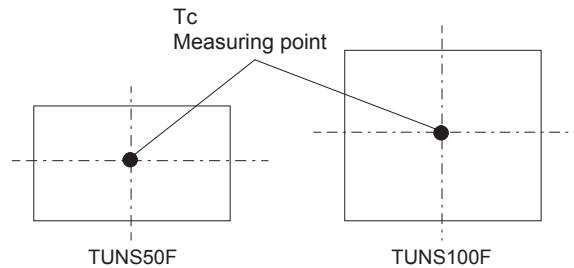
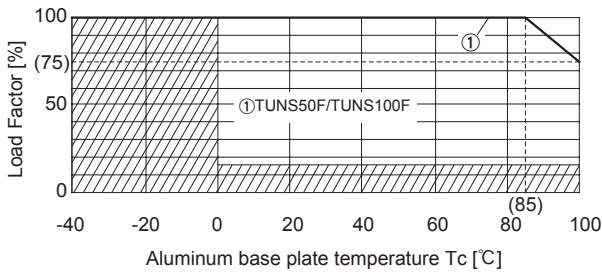

● TUNS300F

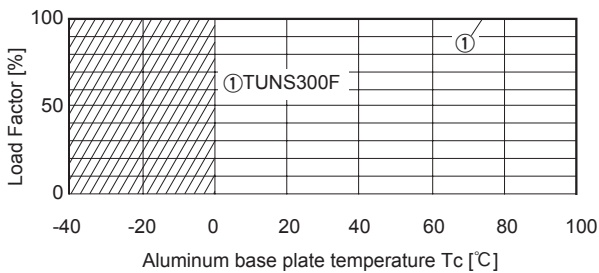

● TUNS500F

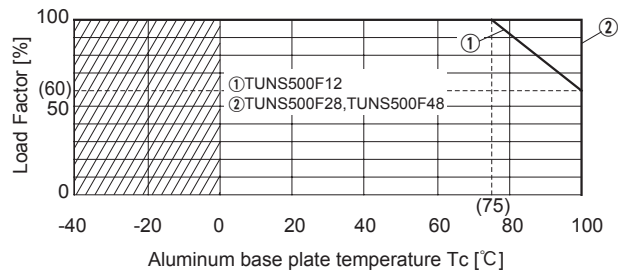

● TUNS700F

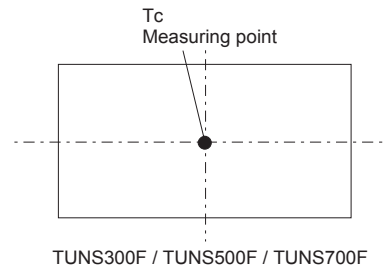
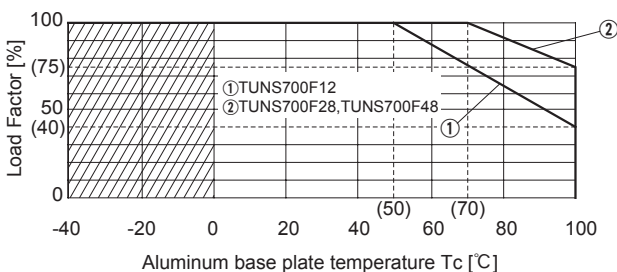

● TUNS1200F

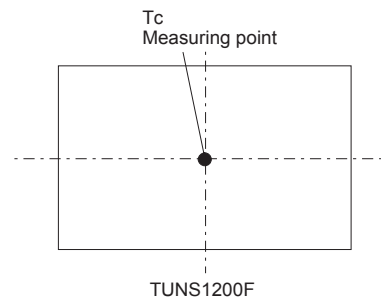
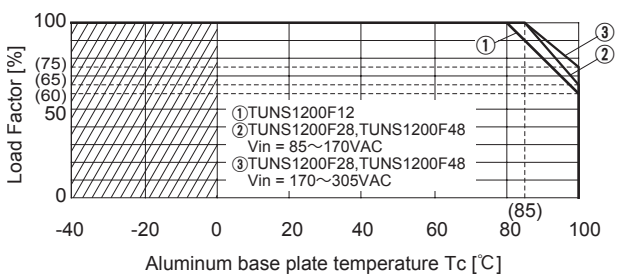

Instruction Manual

◆ It is necessary to read the “Instruction Manual” and “Before using our product” before you use our product.

Instruction Manual <https://en.cosel.co.jp/product/powersupply/TUNS/>
 Before using our product <https://en.cosel.co.jp/technical/caution/index.html>

TUNS



NOTICE



Basic Characteristics Data

Model	Circuit method	Switching frequency [kHz]	Input current [A] *1	Inrush current protection circuit	PCB/Pattern			Series/Parallel operation availability	
					Material	Single sided	Double sided	Series operation	Parallel operation
TUNS50F	Active filter	80-600	0.67	Thermistor	Aluminum	Yes		Yes	*2
	Flyback converter	100-300							
TUNS100F	Active filter	80-600	1.3	Thermistor	Aluminum	Yes		Yes	*2
	Forward converter	300							
TUNS300F	Active filter	100	3.6	SCR	Aluminum	Yes		Yes	*2
	Half-bridge converter	400							
TUNS500F	Active filter	100	6.0	SCR	Aluminum	Yes		Yes	*2
	Half-bridge converter	400							
TUNS700F	Active filter	100	8.6	SCR	Aluminum	Yes		Yes	*2
	Half-bridge converter	400							
TUNS1200F	Active filter	100	14	SCR	Aluminum	Yes		Yes	Yes
	Full-bridge converter	400							

*1 The value of input current is at ACIN 100V and rated load.

*2 Refer to instruction manual.